



# How to Get Clean, Dry, Oil-free Compressed Air From Any Compressor

A White Paper By Mark White - Compressed Air  
Treatment Applications Manager



ENGINEERING YOUR SUCCESS.

# Clean, Dry, Oil-free Compressed Air

In this white paper, Mark White, Compressed Air Treatment Applications Manager at Parker Hannifin, explains the differences between oil lubricated and oil-free compressor technologies, the contamination risks associated with each, and how to mitigate those risks by installing the correct purification equipment required to deliver clean, dry, “Technically Oil-free Compressed Air”.

In today’s modern production facilities, the use of compressed air is often pivotal to manufacturing processes. Irrespective of whether the compressed air comes into direct contact with the product or is used to automate a process, provide motive power, package products, or even to generate other gases on-site, a clean, dry, reliable compressed air supply is essential to maintain efficient and cost effective production.

There are many different types of air compressors available today, and due to its efficiency and reliability, the rotary screw compressor has firmly established itself as the technology of choice for many industries and applications.

Choosing a rotary screw compressor can be a daunting task due to the number of manufacturers and the many variants they provide. One of the biggest decisions to make when selecting a screw compressor is whether to select an oil lubricated or oil-free model.

Marketing messages are often aimed specifically at industries such as food, beverage, pharmaceutical, and electronics, and play on the fear that oil is the biggest contamination threat they face from compressed air.

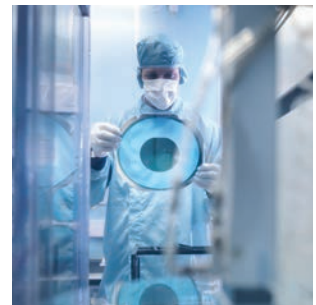

Unfortunately in the pursuit of oil-free compressed air, the downstream air treatment system is often neglected or overlooked completely. For this reason, many users are disappointed to find that oil contamination and water are still present after the installation of their new compressor.

This paper has been developed to provide the reader with an understanding of where oil and other contaminants originate in a compressed air system and how to achieve clean, dry, oil-free compressed air for critical applications.

# Where does oil come from in a compressed air system?

The oil found in a compressed air system will enter from two main sources:

- **Contamination Source 1 - the ambient air (oil vapor)**
- **Contamination Source 2 - the air compressor (liquid oil/oil aerosols/oil vapor)**

Left untreated, oil in one or more of the 3 phases will contaminate the air receiver and distribution piping. It can therefore be said that indirectly, the air receiver and piping are additional sources of oil contamination (3 and 4).

- **Source 3 – The Air Receiver**
- **Source 4 – The Distribution Piping**

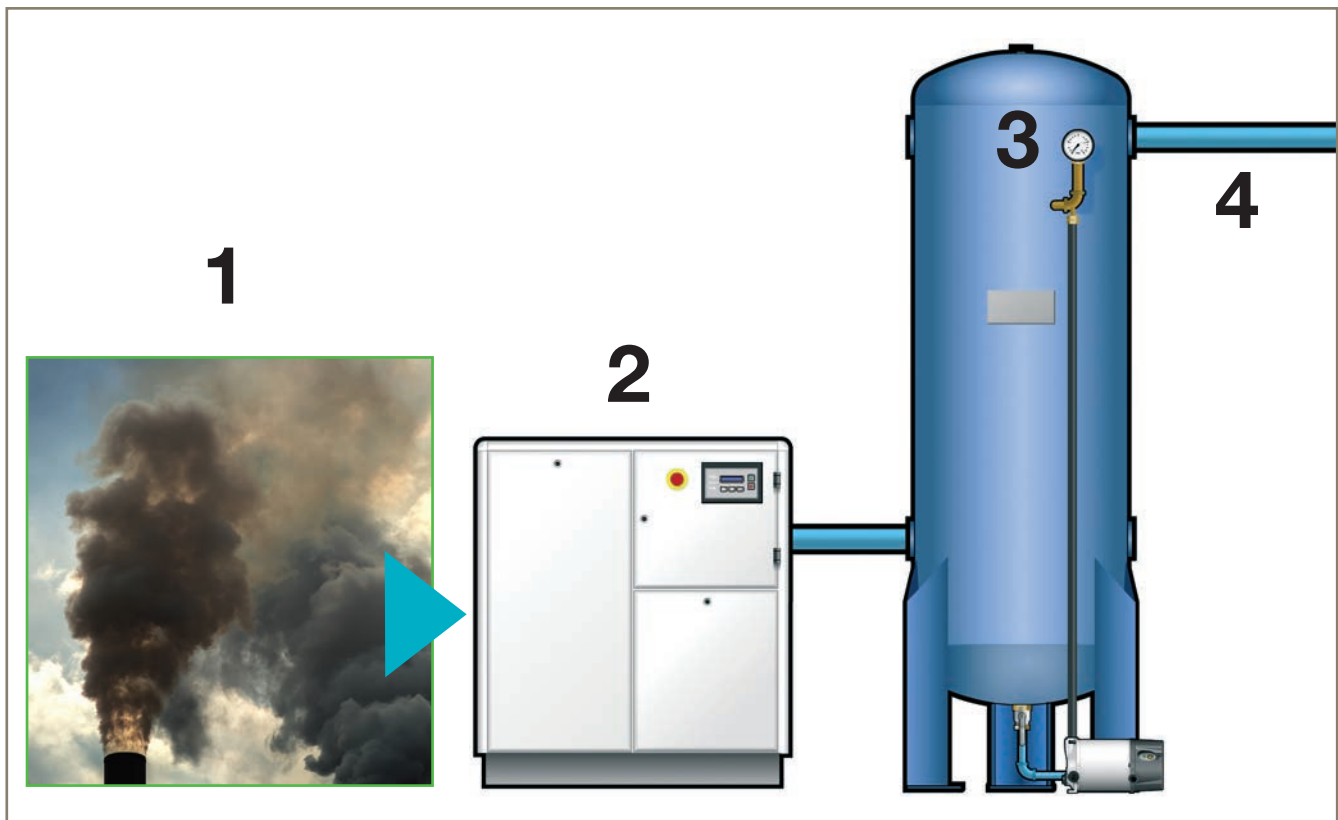

# Contamination Source 1 - The Ambient Air

Ambient air contains oil in a gaseous form (oil vapor). The oil vapor in ambient air is actually a combination of hydrocarbons and VOC (Volatile Organic Compounds) which come from natural sources as well as from vehicle exhausts and inefficient industrial processes.

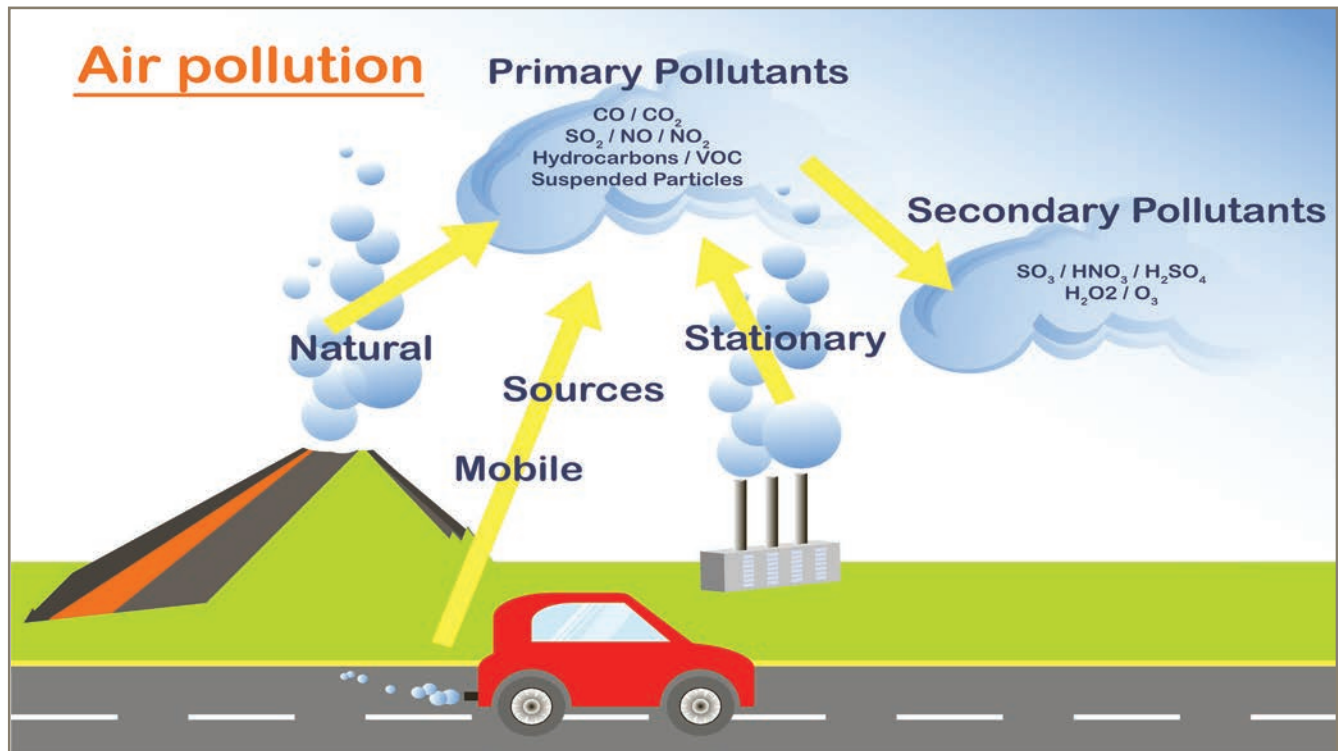

## How much “Oil Vapor” is in the ambient air?

Typical values quoted for oil vapor contamination state that 1 cubic meter of ambient air typically contains between 0.05mg/m<sup>3</sup> and 0.5mg/m<sup>3</sup> of oil vapor.

This however can be higher in dense, urban or industrial environments or next to car parks and busy roadways.

Oil vapor levels are difficult to measure as there is no single “oil” in air test available (at least not a very accurate one). Therefore for accuracy, one must test the ambient air for the different compounds and combine the test results.



Global targets to improve air quality has led to many air quality sample stations being set up. These typically test for the compounds which are more harmful to human health (NO<sub>x</sub>, SO<sub>x</sub>, CO, CO<sub>2</sub> and Ozone). A number of these facilities also test for additional compounds, especially the VOC. We can therefore use this data to verify the presence of “Oil Vapor” in the ambient air.

# Independent Test Data

In the United Kingdom, DEFRA (Department for Environment, Food and Rural Affairs) freely publishes data obtained from their UK sampling facilities. Most of these sites (30+) use manual sampling and test methods, looking for specific hazards, while 4 sites (2 rural and 2 urban) use sophisticated automated thermal desorption with in situ gas chromatography and FID detection equipment. At these sites, automatic hourly measurements are made of 29 different “target” compounds.

Totals for the 29 Compounds of Interest	Maximum Hourly Concentration - Year 2012			
	Auchencorth Moss	Harwell	Eltham	Marylebone Rd
Totals (mg/m <sup>3</sup> )	0.37	0.16	0.44	0.86

Totals for the 29 Compounds of Interest	Maximum Hourly Concentration - Year 2013			
	Auchencorth Moss	Harwell	Eltham	Marylebone Rd
Totals (mg/m <sup>3</sup> )	0.34	0.12	0.44	0.57

Totals for the 29 Compounds of Interest	Maximum Hourly Concentration - Year 2014			
	Auchencorth Moss	Harwell	Eltham	Marylebone Rd
Totals (mg/m <sup>3</sup> )	0.26	0.20	0.64	0.74

Totals for the 29 Compounds of Interest	Maximum Hourly Concentration - Year 2015			
	Auchencorth Moss	Harwell	Eltham	Marylebone Rd
Totals (mg/m <sup>3</sup> )	0.16	0.08	0.40	0.51

As can be seen in the tables above, when the recorded data for all 29 compounds is combined, it corroborates the typical industry figures used for oil (hydrocarbons) in ambient air of between 0.05 mg/m<sup>3</sup> - 0.5 mg/m<sup>3</sup>.

## Important Notes Regarding DEFRA results:

- Global and EU reports only target substances of concern or those which are hazardous to human health.
- They do not necessarily measure compounds hazardous to process health e.g. the taste of a product that is in direct contact with compressed air during manufacture).
- Many species (compounds) which are less (or not) harmful to human health, slip through the detection net, as the chemist/analyst isn't looking for them and has no interest in them.
- These chemicals still exist in the ambient air and their contribution to the “true” total VOC level is lost (but must always be considered).
- The reported VOC level is therefore much lower than reality.
- From the summary tables, we can see that some sites are within the typical values of between 0.05mg/m<sup>3</sup> and 0.5mg/m<sup>3</sup>, while one exceeds these typical values.
- As the test sites used by DEFRA and highlighted in their reports are not testing for every VOC, only those of interest, the values in the summary tables should therefore be viewed as “best case”.



# How does the ambient oil vapor contaminate the compressed air?

As the compressor is running, large volumes of ambient air are drawn into the compressor intake. This ambient air may look clean, but it is not as the gaseous contaminants often cannot be seen.

The invisible oil vapor present in the ambient air is therefore sucked into the air compressor intake along with other contamination.

Once in the compressed air distribution system, some of the oil vapor will cool and condense to form liquid oil and oil aerosols.

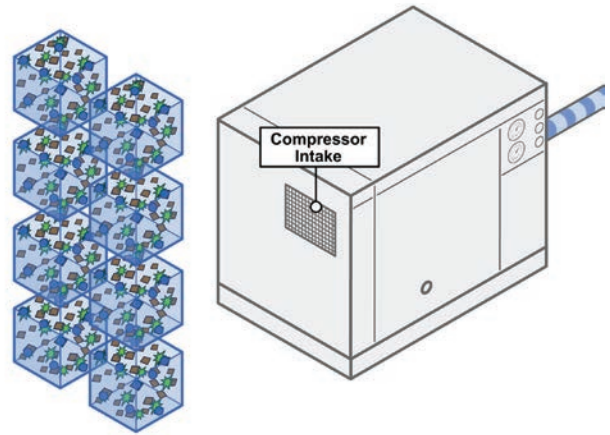

## When Compressing Air, The Problem Increases

To many, the ambient levels of 'oil vapor' may be considered "negligible", however when we talk about oil vapor in the compressed air, we must also consider the effect that compressing the air has on the ambient contamination, the amount of air flowing into the compressed air system and the length of time the compressor is operating.

## Compression = Concentration

When the ambient air is compressed, it is "squeezed" down into a smaller volume. Unfortunately, this does not apply to the contaminants in the ambient air which instead are concentrated. The higher the pressure the air is compressed to, the higher the concentration of contamination.

Typical values quoted by the compressed air industry for oil vapor in ambient air are between 0.05 mg/m<sup>3</sup> and 0.5 mg/m<sup>3</sup>.

Recorded values are shown to confirm these values or are in fact higher.

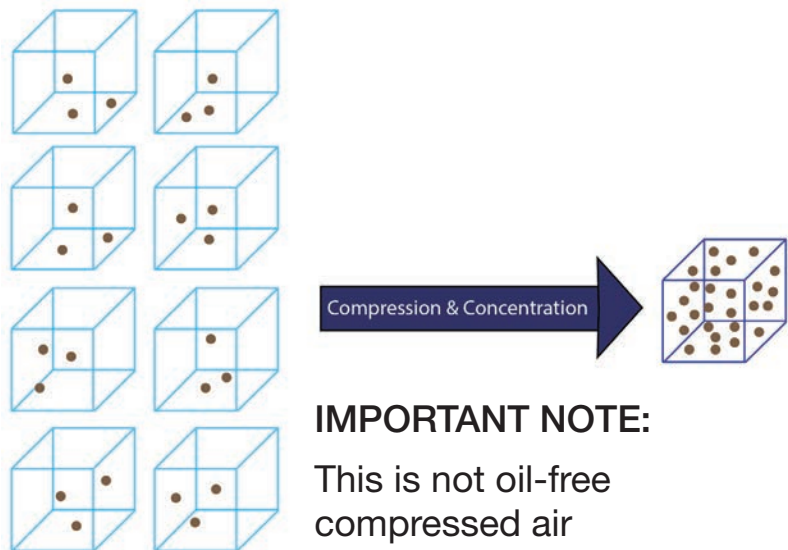

### IMPORTANT NOTE:

This is not oil-free compressed air

## Concentration Examples

To highlight the effect of concentration, the table below contains the maximum hourly oil vapor concentration values from page 5 (averaged from the values recorded over the 4 years).

### Recorded Contamination Levels in 1 Cubic Meter of Ambient Air Before Compression

Pressure	Industry Values		Recorded Ambient Values (Averages over 4 years)			
	Min	Max	Auchencorth Moss	Harwell	Eltham	Marylebone Rd
0 bar g	0.05	0.5	0.29	0.14	0.48	0.67

The table below highlights the increased ‘oil vapor’ contamination levels that 1 cubic meter of compressed air would contain (at industry typical operating pressures).

### Oil Vapor Contamination Levels 1 Cubic Meter of Compressed Air

Pressure	Industry Values		Effect of Compression on Recorded Ambient Values			
	Min	Max	Auchencorth Moss	Harwell	Eltham	Marylebone Rd
7 bar g	0.40	4.00	2.32	1.12	3.84	5.36
10 bar g	0.55	5.50	3.19	1.54	5.28	7.37
13 bar g	0.70	7.00	4.06	1.96	6.72	9.38
40 bar g	2.00	20.0	11.6	5.6	19.2	26.8
All Concentration Values in mg/m <sup>3</sup>						

### Negligible Values

So, what may appear as negligible values in the ambient air, are no longer negligible once the concentrating effects of compression is taken into consideration.

### Volumetric Flow and Time

Another consideration is the volumetric flow rate of the air compressor. Most people look at the figures per cubic meter of ambient air and forget to work out how many cubic meters per hour their air compressor is delivering into their distribution piping system. Air compressors are constantly operating, constantly drawing in the contaminated air and constantly adding to the concentration of contamination.

### Compressor Intake Location

We have discussed the levels of oil vapor in the ambient air, however there is also another factor to consider and this is the proximity of the compressor intake to parking lots and roads. It is extremely common to find air compressors installed next to parking lots and garages, site transportation hubs (goods in/out) or major roads and motorways. The effect of vehicular movement next to the compressor intake raises the risk associated with harmful VOC considerably, especially if a vehicle can park or wait with its engine running right next to the compressor intakes.



# Contamination Source 2 - The Air Compressor

## Overview of Screw Compressor Operation

### Oil Injected (Lubricated)

There are number of different terms used to describe a lubricated compressor (Oil Injected/Oil Lubricated/Contact Cooled), however, the designs all have one thing in common; they use oil for sealing, cooling, and lubrication. In fact, the lubricated compressor accounts for approximately 75% of industrial screw compressors sold globally.

As the rotary screw compressor is he most common, this type has been used to describe the basic operation of an oil injected compressor.

### Basic Operation – Oil Injected Rotary Screw Compressor

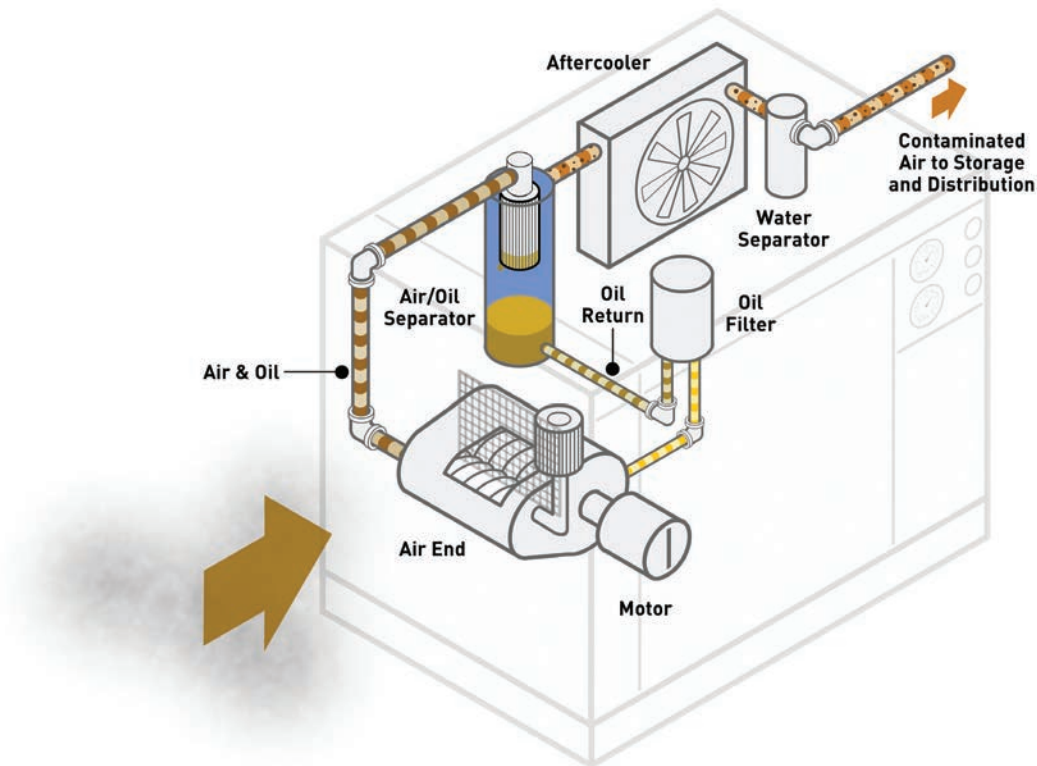
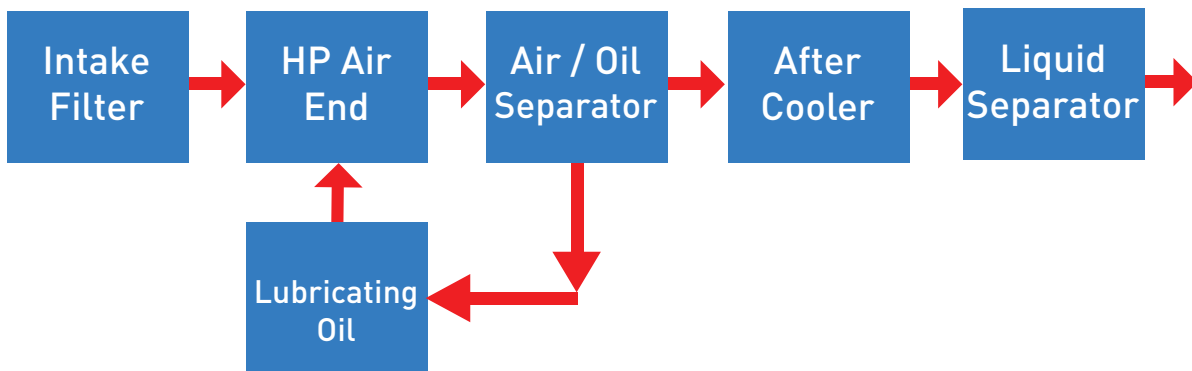



## Drive

A motor, usually electric (sometimes diesel on portable compressors), is used to drive the compression stage.

## Compression

The compression stage, commonly known as the 'air end'. It consists of two inter-meshing rotors (helical screw), one male, one female. One rotor is typically driven directly by the motor (its speed governed by gearing) while the other is typically freely rotating (pushed by the lubricating oil).

As the screws rotate, ambient air is pulled into the air end, gets trapped in pockets between the two screws and is compressed. As long as the rotors turn, air is drawn in at one end and is discharged at pressure out of the other.

A non-return valve prevents air discharging back through the compressor when the drive motor is off.

## Sealing

During operation, oil is injected into the compression stage for sealing. The two rotors in the air end do not actually touch each other due to the oil. The oil provides a very efficient seal which allows compression of the ambient air to take place.

## Cooling (of the compressed air during compression/rotors/air end housing)

When the ambient air is compressed, heat is produced (commonly referred to as the heat of compression). The oil in a lubricated compressor directly cools the compressed air, the rotors and the air end housing and up to 80% of the heat in the compression stage can be removed by the oil. This keeps air end discharge temperatures low, increasing efficiency. Typical air temperatures are between 176°F (80°C) and 248°F (120°C), therefore for most industrial operating pressures, using direct cooling with oil allows compression with a single air end only (single stage).

## Lubrication

As air compressors consist of many moving parts (bearings and gears), the oil is also used for lubrication of these components.

## Oil Reclamation

Following compression, the compressed air is now laden with oil. An air/oil separation filter built into a closed loop lubrication system is used to reclaim the oil from the compressed air before it exits the compressor. The oil will be filtered for particulate contamination and cooled before re-circulation, where it will once again be used for sealing, cooling, and lubrication.

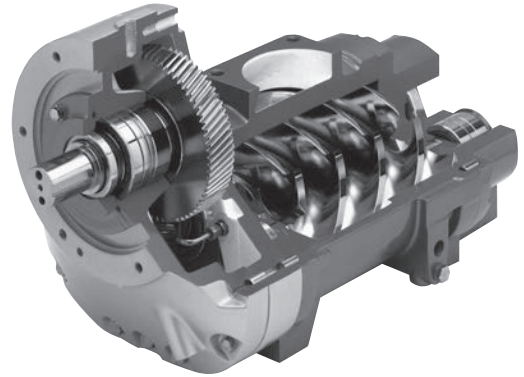

# Overview of Screw Compressor Operation

## Oil Injected (Lubricated)

### Oil Carryover (Aerosol)

The filter used in the air/oil separator is dealing with high levels of liquid oil and oil aerosols.

Due to the way mechanical filters operate, the air/oil separator is unable to reclaim 100% of the oil, resulting in a small amount of oil aerosol remaining in the compressed air leaving the compressor. This is known as 'oil carryover'. Literature for lubricated compressors will usually provide a figure for oil carryover. Typical oil carryover values for common industrial compressor types are shown below:

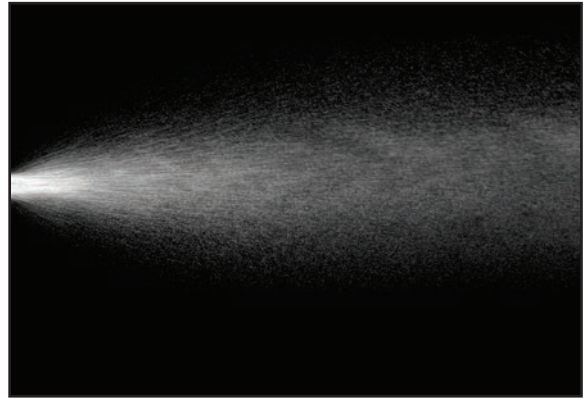

Compressor Type	Typical Oil Carryover Values
Oil Flooded Rotary Screw Compressors	<5 mg/m <sup>3</sup>
Rotary Vane Compressors	<5 mg/m <sup>3</sup>
Reciprocating (Piston) Compressors	New: 25 mg/m <sup>3</sup> /Old: 100-200 mg/m <sup>3</sup>

### Important Note:

Oil Vapor (hydrocarbons and VOC) from the ambient air can be captured by the lubricating oil during compression.

### Oil Carryover (Vapor)

As the lubricating oil heats up during operation, its evaporation rate increases (this will vary between different lubricants). Oil vapor will therefore be introduced into the compressed air by a lubricated compressor. As the oil is in a vapor phase, it will not be reduced by the air/oil separator.



### Post Compression Cooling (Aftercooler)

The air exiting the compression stage of an oil lubricated compressor, although cooled by the lubricating oil, is still too hot for use and will therefore require further cooling. This cooling is carried out by the aftercooler. Many industrial compressors will incorporate an integrated aftercooler inside the compressor package, while some manufacturers may supply these as additional, external items.

Aftercoolers can be split into air cooled and water-cooled variants, with air cooled being the most common.

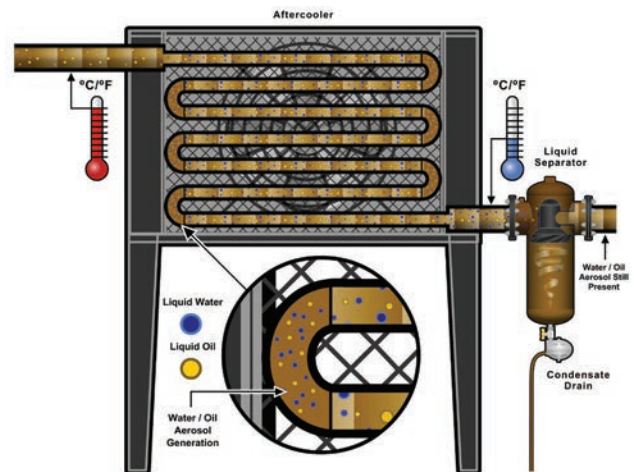

### Air Cooled Aftercooler

This is essentially a long length of piping coiled to form a cooling pack manufactured from materials with high heat transfer properties, many will incorporate additional “cooling fins” attached to the piping for additional heat transfer. A large cooling fan will blow ambient air over the cooling pack, resulting in heat from the compressed air being transferred to the moving ambient air.

A typical air cooled aftercooler will provide discharge air from the compressor approximately 50°F (10°C) to 59°F (15°C) above the ambient air temperature (assuming the compressor room is well ventilated, and the aftercooler is kept clean).



### Water Cooled Aftercooler

On a water-cooled aftercooler, the cooling pack is replaced by multiple straight pipes, integrated into a watertight vessel. Chilled water from a separate closed loop cooling system is constantly circulated around the pipes flowing the compressed air.

Heat from the compressed air transfers into the cooling water (heating it up). Warm water is then returned to the chiller to be cooled once again. Water cooled aftercoolers are often used when ambient air temperatures are too high for an air-cooled aftercooler to be efficient.



### Liquid and Aerosol Introduction

As the aftercooler cools the compressed air, it reduces the air's ability to hold water and oil vapors. Cooling condenses the vapors into liquid water and liquid oil which is carried along in the air at high velocity. Rough internal surfaces of the piping, bends, elbows, fittings, etc. all disrupt the flow of condensed liquids. This disruption causes the condensed liquids to ‘shear’ or atomize, producing fine droplets or aerosols of water and oil.

### Liquid Reduction

Many air compressors are fitted with an integrated water separator at the outlet of the aftercooler to reduce liquids. Some compressor designs rely on an external water separator or use a wet air receiver for liquid reduction.

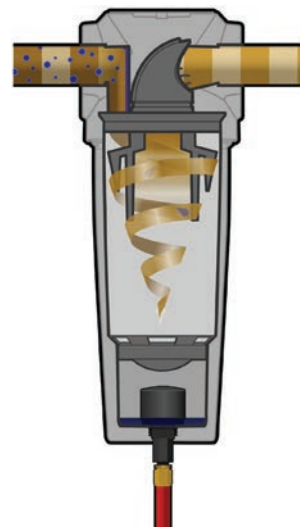

### Important Notes:

Water separators reduce liquids only, they are not effective for aerosol or vapor reduction and they will not remove 100% of the liquid present.

# Contamination Source 2 - The Air Compressor

## Overview of Screw Compressor Operation

### Oil-free

The obvious thought is that the term 'Oil-free compressor' describes a compressor containing no oil. Unfortunately, that is not the case for most oil-free compressors.

An oil-free compressor is the term used to describe a compressor that does not use oil in its compression stage.

### Basic Operation – Oil-free Rotary Screw Compressor

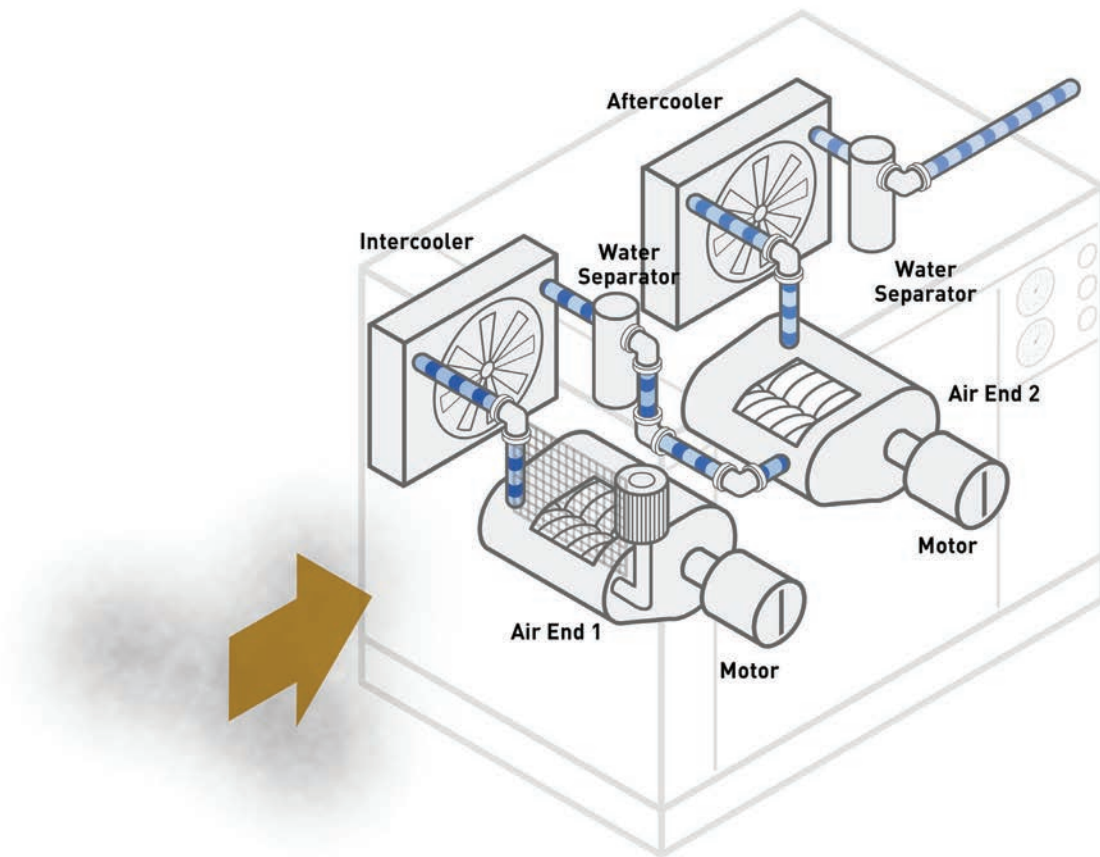

### Drive

Oil-free rotary screw compressors are typically multi stage, driven by a single drive motor. This motor will drive a gear which in turn distributes the power to each air end. Some oil-free screw compressors are now available where each compression stage driven by an individual motor.



## Compression

Unlike the oil injected screw compressor which uses oil to seal the gaps between the rotors and provide compression, oil-free variants achieve compression in an alternative way.

Rotor elements are manufactured in pairs with extremely tight tolerances to decrease the gap between them. During operation, rotors are spun at much higher speeds than an equivalent oil injected compressor. Specialist coatings are often applied to the rotors to give some of the protection from water and heat usually provided by oil.

The rotors operate extremely close to each other, however as there is no oil in the compression stage to prevent the rotors from touching, the distance between each rotor is maintained by additional gearing.



## Cooling

As there is no oil in the compression chamber to provide direct cooling, indirect cooling is used. The air end housings of oil-free compression stages typically contain galleries in which cooling water (on water cooled machines) or oil (on air cooled machines) can be circulated. This process is not as efficient as direct cooling as it only cools the casing and not the compressed air or the rotors.

Due to the lack of direct cooling in an oil-free compressor, the compressed air and rotors reach much higher temperatures. Oil-free compressors therefore obtain their final discharge pressure in stages (as opposed to oil injected machines which typically use only 1 stage). Between stages they will cool the compressed air with an intercooler. This keeps typical air end temperatures between 356°F (180°C) and 392°F (200°C).

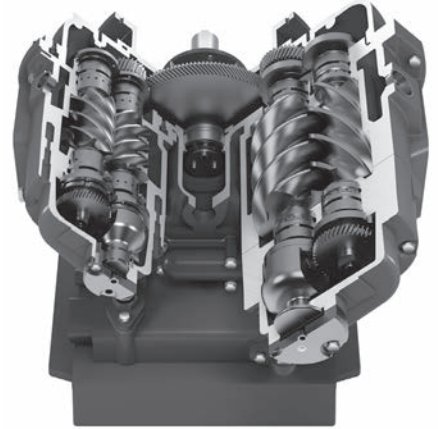

For example, on a typical oil-free rotary screw compressor with 2 compression stages, an intercooler and aftercooler.

Stage 1 will typically compress the air up to a pressure around 3.5 bar g, stage 2 will then compress the air to the discharge pressure of 7 bar g.

## Lubrication

On an oil-free screw compressor, it is not only important that the individual rotors in each air end are synchronised with gears, with only one drive motor, additional gearing is also required to drive each of the air ends. All of the gearing and bearings require lubrication.

So although the name implies that an oil-free compressor is “oil less”, for most oil-free compressors sold, this is not the case. Oil is not used in the compression stages; however, oil is still required for lubrication and cooling of other components. This oil is pumped around the compressor forming a closed loop system which lubricates bearings and gears, is filtered, cooled, and recirculated.

## Oil Reclamation (Air/Oil Separator)

As there is no oil used in the compression stage, there is no requirement for an air/oil separator on an oil-free compressor.



# Overview of Screw Compressor Operation

## Oil-free

### Oil Carryover (from the ambient air)

It is often thought that an oil-free compressor will provide oil-free compressed air (due to the fact it does not use oil in the compression of the air). Unfortunately this is not true.

Oil vapors in the ambient air are drawn into the compressor intake, compressed and concentrated. The concentrated vapors then enter the compressed air distribution system where they can cool and condense. This results in the presence of oil contamination (in a liquid, aerosol and vapor phase).

The amount of oil in the compressed air downstream of an oil-free compressor is primarily dependent upon the ambient air quality.

The table (right) highlights the increased 'oil vapor' contamination levels that 1 cubic meter of compressed air would contain (at typical industry operating pressures).

Additionally, many compressor intakes are sited in industrial areas and/or next to parking lots and roads, where the ambient contamination levels can be significantly higher, leading to higher concentrations once compressed.



Pressure	Industry Values	
	Min	Max
Ambient	0.05	0.50
7 bar g	0.40	4.00
10 bar g	0.55	5.50
13 bar g	0.70	7.00
40 bar g	2.00	20.0

All Concentration Values in mg/m<sup>3</sup>

### Oil Carryover (from the compressor)

The oil used in the closed loop system of the oil-free compressor to cool and lubricate the bearings and gears heats up and vaporizes during operation.

The compressor is fitted with a simple 'breather' filter to prevent over pressurization of the oil circuit.

This breather filter allows aerosols and vapors to exit the casing and be drawn into the compressor intake, which in turn increases the amount of oil contamination going downstream.

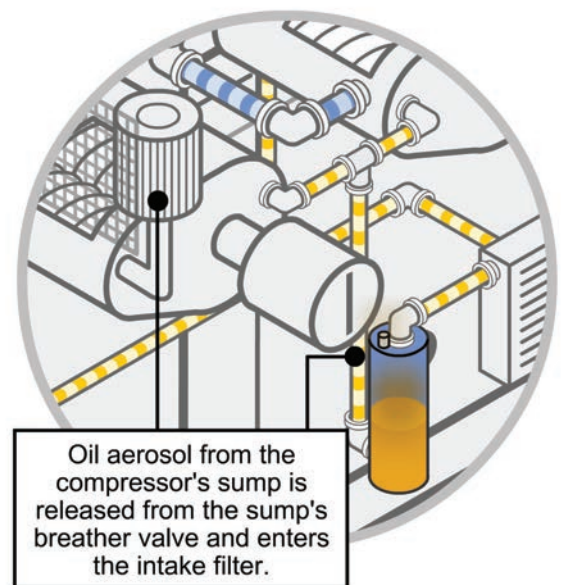

### Intercooling/Aftercooling

Without the ability to provide direct cooling with oil, oil-free machines typically use two compression stages. Placed in between the two stages is an intercooler which cools the air down. The air then enters the second compression stage where it again heats up due to compression. Before exiting the compressor, the compressed air passes through an aftercooler to cool it to a more usable level.

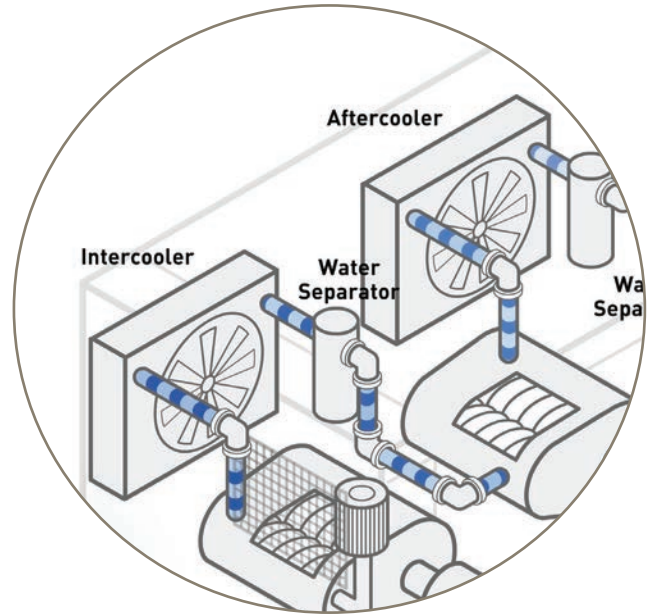

### Liquid and Aerosol Introduction

As the intercooler and aftercooler cool the compressed air, it reduces the air's ability to hold water and oil vapors. Cooling condenses the vapors into liquid water and liquid oil which is carried along in the air at high velocity. Rough internal surfaces of the piping, bends, elbows, fittings, etc. all disrupt the flow of condensed liquids. This disruption causes the condensed liquids to 'shear' or atomize, producing fine droplets or aerosols of water and oil.

### Liquid Reduction

Many air compressors are fitted with an integrated water separator at intercooler and at the outlet of the aftercooler to reduce liquids. Some compressor designs rely on an external water separator or use a wet air receiver for liquid reduction.

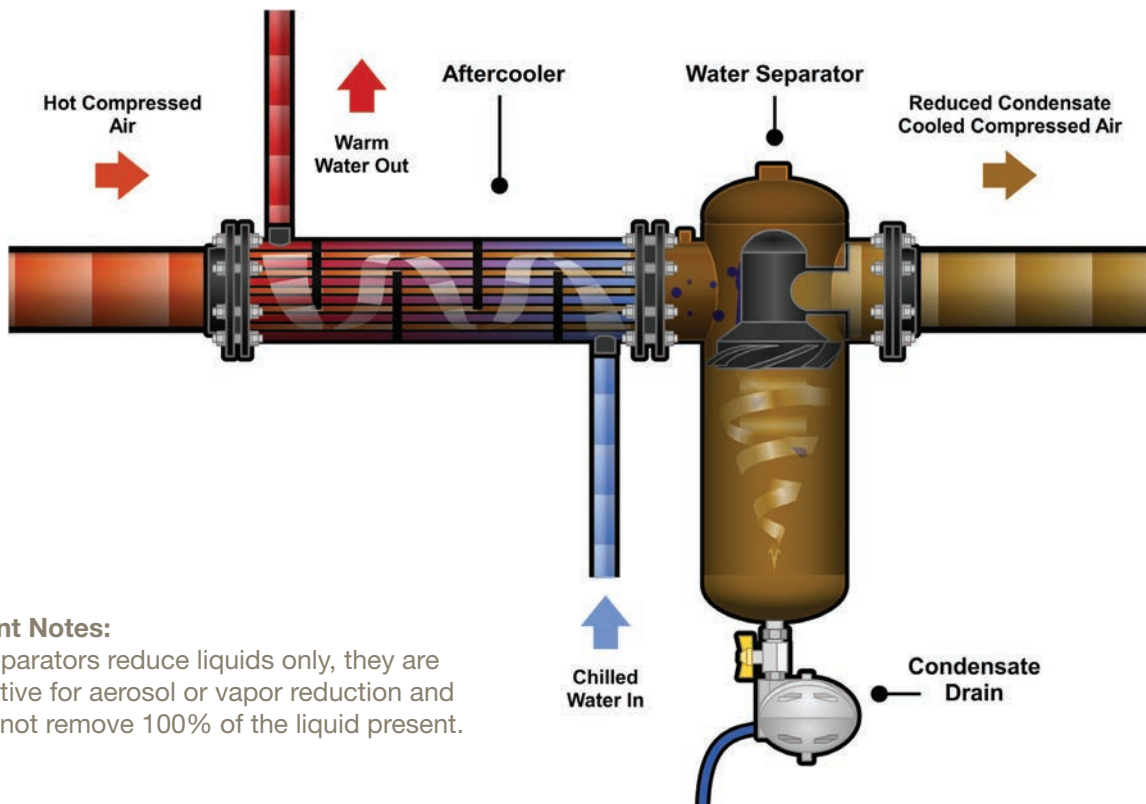

### Important Notes:

Water separators reduce liquids only, they are not effective for aerosol or vapor reduction and they will not remove 100% of the liquid present.

# Using International Standards to Specify Oil-free Compressed Air

## ISO8573 series

ISO8573 series is the most commonly used standard for compressed air. It is made up of 9 separate parts. Part 1 refers to air purity (quality), while parts 2 to 9 provide details on the equipment and methodology to be used to accurately measure for different contaminants in a compressed air system (and meet the air purity classifications shown in part 1).

## ISO8573-1 – International Standard Relating to Compressed Air Purity

ISO8573-1 provides the user a way of specifying an air purity (quality) required for the entire compressed air system and/or for individual usage points (based upon application requirements). It also allows equipment manufacturers to easily show product performance and specify purification equipment to meet the end users air purity specification.

In ISO8573-1, compressed air contaminants are grouped into Particulate, Water, and Total Oil (ISO8573 parts 2 to 9, looks at test methods by phase, i.e. water as liquid or vapor and oil as liquid, aerosol and vapor). Different levels of contamination are then assigned “Purity Classes”. When using ISO8573-1 to define the air quality required at a usage point, the specification should be written as follows:

First the standard (ISO8573-1) must be written, then the year (revision) stated then the purity classes (Separated with a colon), e.g. ISO8573-1:2010 [A:B:C:].

Where:

A is the purity class for particles

B is the purity class for humidity (vapor) and liquid water

C is the purity class for total oil (aerosol, liquid and vapor)

## Compressed Air Purity Classes

ISO8573-1:2010 CLASS	Solid Particulate			Mass Concentration mg/m <sup>3</sup>	Water		Oil Total Oil (aerosol liquid and vapor) mg/m <sup>3</sup>
	Maximum number of particulates per m <sup>3</sup>				Vapor Pressure Dewpoint	Liquid g/m <sup>3</sup>	
	0.1 - 0.5 micron	0.5 - 1 micron	1 - 5 micron				
0	As specified by the equipment user or supplier and more stringent than Class 1						
1	≤ 20,000	≤ 400	≤ 10	—	≤ -70°F	—	0.01
2	≤ 400,000	≤ 6,000	≤ 100	—	≤ -40°F	—	0.1
3	—	≤ 90,000	≤ 1,000	—	≤ -20°F	—	1
4	—	—	≤ 10,000	—	≤ +3°F	—	5
5	—	—	≤ 100,000	—	≤ +7°F	—	—
6	—	—	—	≤ 5	≤ +10°F	—	—
7	—	—	—	5 - 10	—	≤ 0.5	—
8	—	—	—	—	—	0.5 - 5	—
9	—	—	—	—	—	5 - 10	—
X	—	—	—	> 10	—	> 10	> 10

# Class Zero/Class 0

## What Is It?

Almost all oil-free rotary screw compressors are sold under the banner of Class 0. But what is it and what does it mean?

Class 0 (or Class Zero) is actually a reference to an ISO8573-1 air purity classification, although this is not always stated. It is also often referred to as an 'oil' contamination classification, when in fact it can be applied to both particulates and water.

When ISO8573-1 was first developed, the classification for each contaminant (particulate/water/total oil) had a value associated to it. However, in 2001, the standard was updated and Class 0 was introduced for all 3 contaminants (this carried through to the 2010 update). It was introduced as a "customizable" specification for users or manufacturers to use should the air purity requirement (users) or delivered air quality (for equipment manufacturers) be more stringent (cleaner) than Class 1.

ISO8573-1:2010 CLASS	Solid Particulate			Mass Concentration mg/m <sup>3</sup>	Water		Oil
	Maximum number of particulates per m <sup>3</sup>				Vapor Pressure Dewpoint	Liquid g/m <sup>3</sup>	Total Oil (aerosol liquid and vapor)
	0.1 - 0.5 micron	0.5 - 1 micron	1 - 5 micron				mg/m <sup>3</sup>
0	As specified by the equipment user or supplier and more stringent than Class 1						
1	≤ 20,000	≤ 400	≤ 10	—	≤ -70°F	—	0.01
2	≤ 400,000	≤ 6,000	≤ 100	—	≤ -40°F	—	0.1

Unfortunately, the ISO8573-1 Class 0 classification is often misunderstood and/or misapplied to air compressors or treatment products. It is important to remember:

- **Class 0 does not mean zero contamination.**
- **Class 0 does not mean oil-free air.**
- **Class 0 does not solely refer to oil contamination.**
- **A Class 0 specification must be 'cleaner' than the Class 1 specification for the contaminant chosen**
- **The contamination levels stated for a Class 0 specification must also be within the measurement capabilities of the test equipment and test methods shown in ISO8573 Pt 2 to Pt 9.**
- **The Class 0 specification must clearly state which contaminant the it refers to.**
  - i.e. "Solid Particulate", "Water" or "Total Oil (aerosol, liquid and vapor)"
- **Class 0 requires the user or the equipment supplier to show a contamination level as part of a written specification.**

Example of a correctly written Class 0 specification -

"When preceded by OIL-X Grade AO General Purpose and Grade AA High Efficiency Coalescing Filters, OIL-X OVR Grade Adsorption Filters provide a delivered air quality in accordance with ISO8573-1:2010 Class 0 (≤0.003 mg/m<sup>3</sup>) for total oil (oil aerosol and oil vapor)".

- **The agreed Class 0 specification must be written on all documentation to be in accordance with the standard.**
- **Stating Class 0 without an accompanying contaminant specification is meaningless and not in accordance with the standard.**

# “Oil-free” Compressed Air

What does “oil-free” mean and is it achievable?

## “Oil-free” Compressed Air

The term oil-free implies “compressed air which is free of oil” or “compressed air without traces of oil”. It is a misleading term use and one difficult to prove or guarantee in practice.

## Accurate Measurement of Oil in Compressed Air

It is not possible to accurately measure oil in compressed air down to a zero value and state that compressed air is “oil-free”. A review of the relevant ISO 8573 standards will confirm this. To measure “total oil” in compressed air requires the user to test for oil aerosol and oil vapor in accordance with the methodology, and using the test equipment shown in ISO8573-2 and ISO8573-5 respectively and combine the results. The limit of accurate measurement for “total oil” is 0.003 mg/m<sup>3</sup>.



# “Technically Oil-free Air”

## What is “Technically Oil-free Air”?

“Technically oil-free air” is the term given to compressed air that has been treated to reduce the liquid oil, oil aerosol, and oil vapor content to extremely low (but measurable) levels.

It is sometimes used to imply an inferior quality of compressed air compared to the so called “oil-free” air delivered by an oil-free compressor, when in fact the treated air will be of a higher quality.

Technically oil-free compressed air is as close to oil-free compressed air as is possible and levels total oil in compressed air levels down to 0.003 mg/m<sup>3</sup> and achievable.

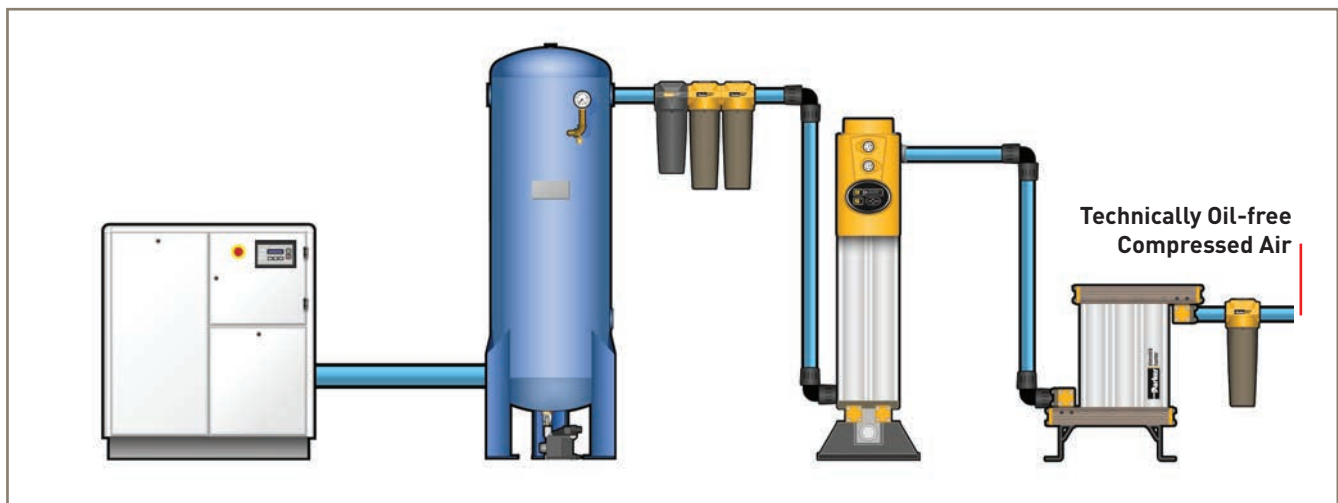



# Can Oil-free Compressors without Treatment Equipment Guarantee Oil-free Air?

Simply, no. Let's look at the facts regarding oil in a compressed air system.

## Ambient Air Contamination

Air compressors are constantly drawing in large volumes of ambient air and compressing it. The ambient air contains contamination which includes oil in a vapor phase (hydrocarbons and VOC). As the air is compressed, the contamination is not, and it is therefore concentrated. Even if ambient levels of oil vapor were low, the concentration is higher in the compressed air. Untreated, this can cool and condense in the compressed air system and point of use to produce oil in a liquid, aerosol, and vapor phase at the application.

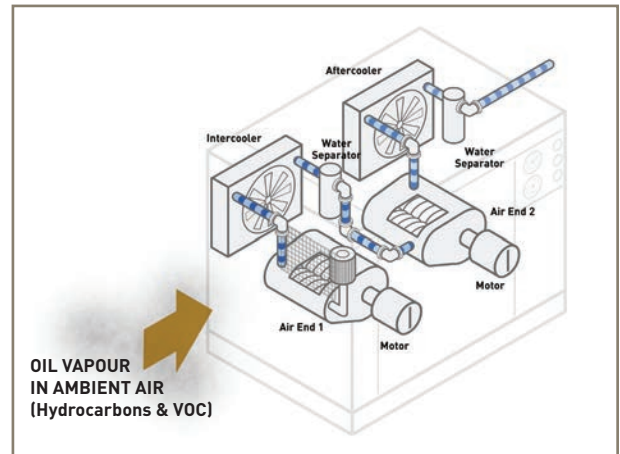

## Contamination from the Oil-free Compressor

Most oil-free compressors are not "oil less", they require lubricating oil for gearboxes and bearings. While the oil is not used in the compression stages, it can still find its way into the compressed air. Oil systems need to be vented and the crank case vent filter is unable to stop lubricating oil from entering the compressor intake in a vapor phase. The compressor will also use seals around bearings, however as seals wear, there is the possibility for oil to bypass and enter the compressed air stream.

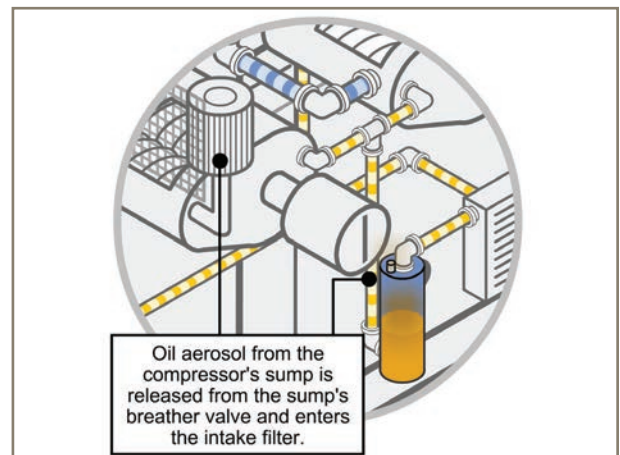

## Contamination Already in the Distribution Piping System

Even if we were to assume that the compressed air leaving the compressor was totally free from oil (which it is not), it could not be guaranteed to be so at the point of use. Piping systems will store contamination, including oil, and even after the installation of a new compressor and purification system, contaminants can be present at applications unless treated at the point of use. If ISO8573-1 Class 1 or Class 0 for total oil is required for an application, it is more sensible to provide this at the point of use, not in the compressor room (and often more cost effective too).



# Oil-free Compressor or Technically Oil-free Compressed Air?

What should I specify to protect my products, processes and brand reputation?

There are many production facilities where the compressed air directly or indirectly contacts production equipment, products or packaging materials (especially in the food, beverage, pharmaceutical and electronics industries) and in these instances, contaminants from untreated compressed air can have a serious impact on product quality, consumer safety and brand reputation.

## Common Mistakes with Specifications

It is not uncommon for manufacturers and auditors in these industries to insist that an “oil-free” compressor or “Class 0” compressor be installed. This is often in the mistaken belief that the oil-free compressor will guarantee oil-free or contaminant-free compressed air.

## Offsetting Cost

These specifications often also reduce the compressed air filtration requirements (or eliminate them) as they believe the compressed air delivered by the oil-free compressor has fewer contaminants or is actually free of contamination. This is also done to offset the additional cost of the oil-free compressor.

Changing a facility to an oil-free compressor can impose a huge cost burden which is often hidden up front. And most importantly, it is self-imposed, there is no legislation or standard for any industry stating that only oil-free compressors should be installed.



## Specifying Correctly

What should be specified is “Technically Oil-free Compressed Air”, i.e. ISO8573-1:2010 Class 1 for total Oil or ISO8573-1:2010 Class 0 (0.003 mg/m<sup>3</sup>) for Total Oil. It is important to understand that Technically Oil-free Air can be achieved from both oil-free and oil lubricated compressors. Unfortunately, oil lubricated compressors are often overlooked due to fear induced by oil-free compressor marketing campaigns and the perceptions mentioned previously.

# How do You Achieve 'Technically Oil-free' Compressed Air?

Approximately, 75% of the industrial screw compressors sold globally are oil lubricated (oil injected/contact cooled). These are typically installed with downstream purification equipment (water separators and coalescing filters) to treat the compressed air, reducing oil in a liquid and aerosol phase. For critical applications an adsorption filter will also be included for the treatment of oil vapor. Compressed air treated in this way is said to be 'Technically Oil-free' and with the installation of the correct purification equipment will be in accordance with ISO8573-1 (international standard for compressed air purity) Class 0 or Class 1 for Total Oil.

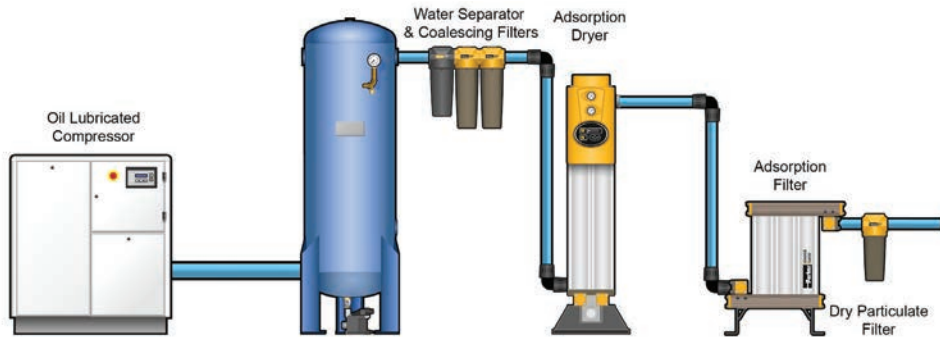

When using an oil-free compressor, if the user wishes to achieve the same 'Technically Oil-free' air quality in accordance with ISO8573-1 Class 0 or Class 1 for total oil, the purification equipment required downstream of the compressor is identical. Installing purification equipment will ensure treatment of the 'oil' vapor drawn into the compressor intake (including the vapor which condenses to form liquid oil and oil aerosols).

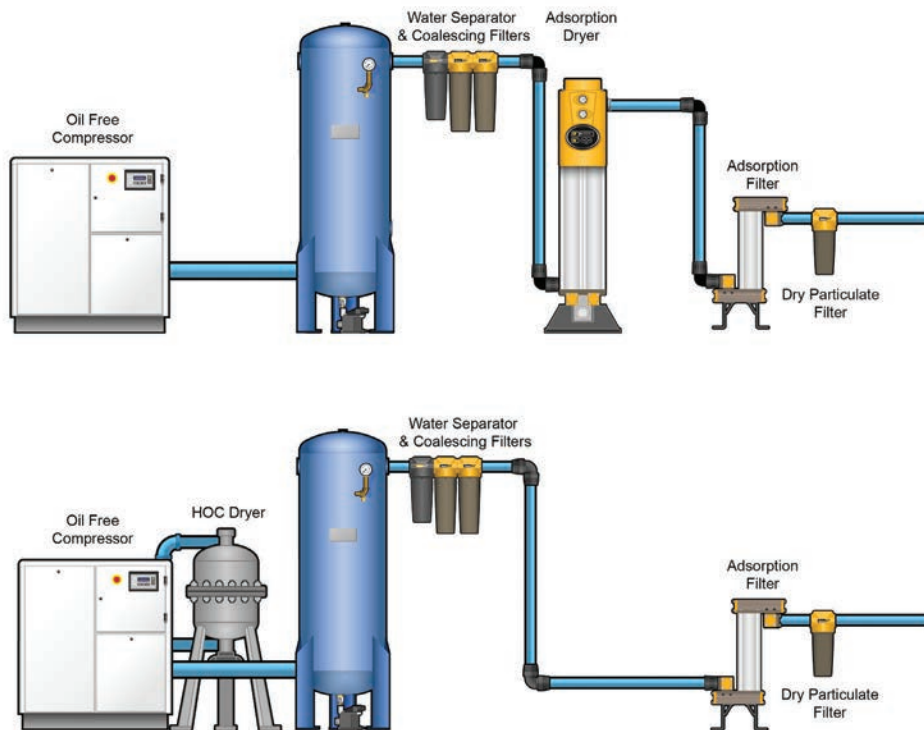

# Where to Specify Technically Oil-free Compressed Air

Where should I specify my highest air quality requirements, in the compressor room or at the point of use?

To achieve “Technically Oil-free Compressed Air” requires a careful approach to system design. Any air quality specification should look at treating the air both in the compressor room (to a level enough to protect the distribution piping from contamination and provide general purpose air) and include additional treatment at each point of use (to protect critical applications).

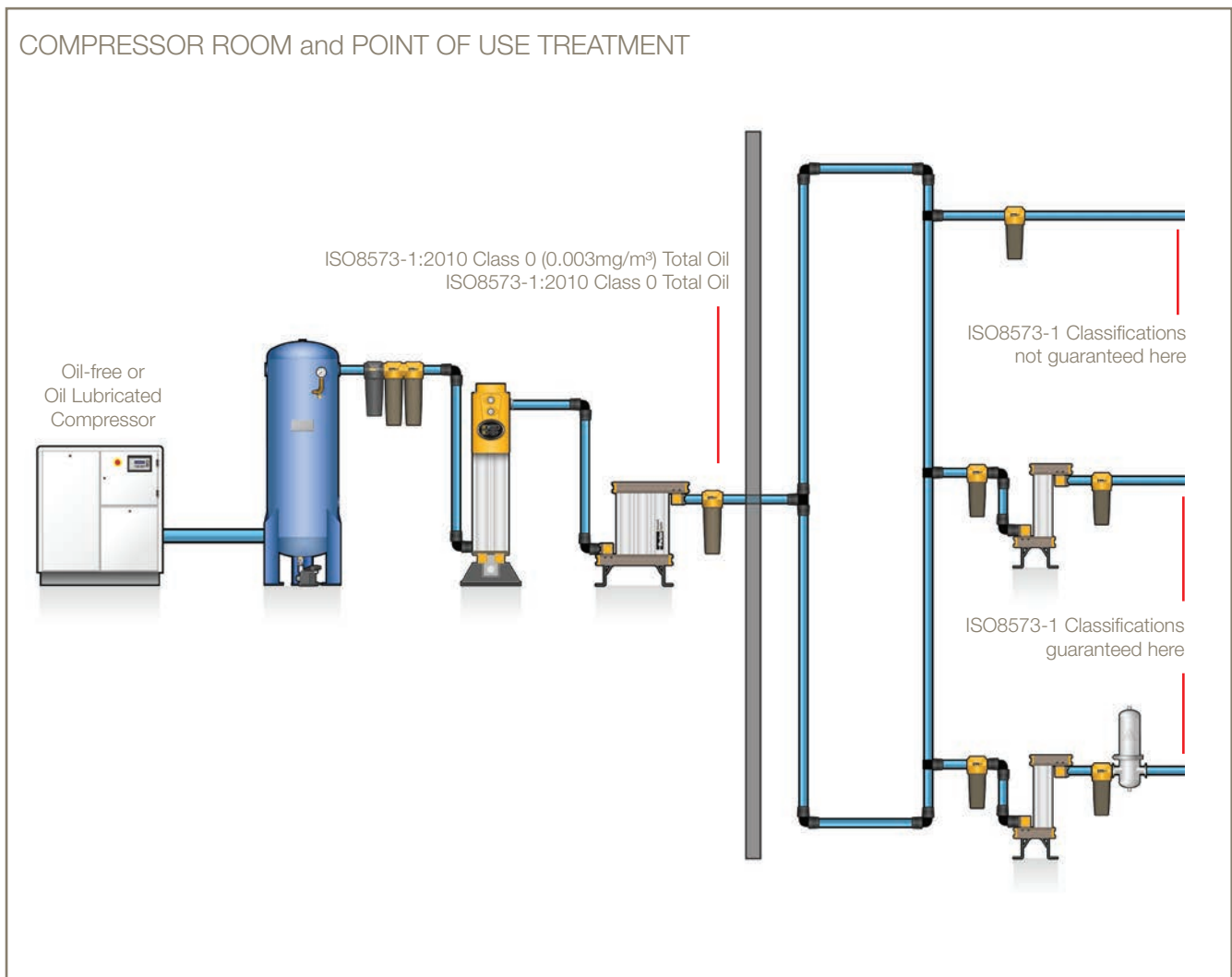

Important Note: Compressor room air purity can be equal to the desired point of use air purity (as shown above) or of a lower specification and brought up to the desired specification with point of use purification equipment.

Treatment only in the compressor room will allow the compressed air to pick up contamination in the piping system (including oil, particulates and micro-organisms). The ISO air purity specified will be at the last filter only and not at the point of use.

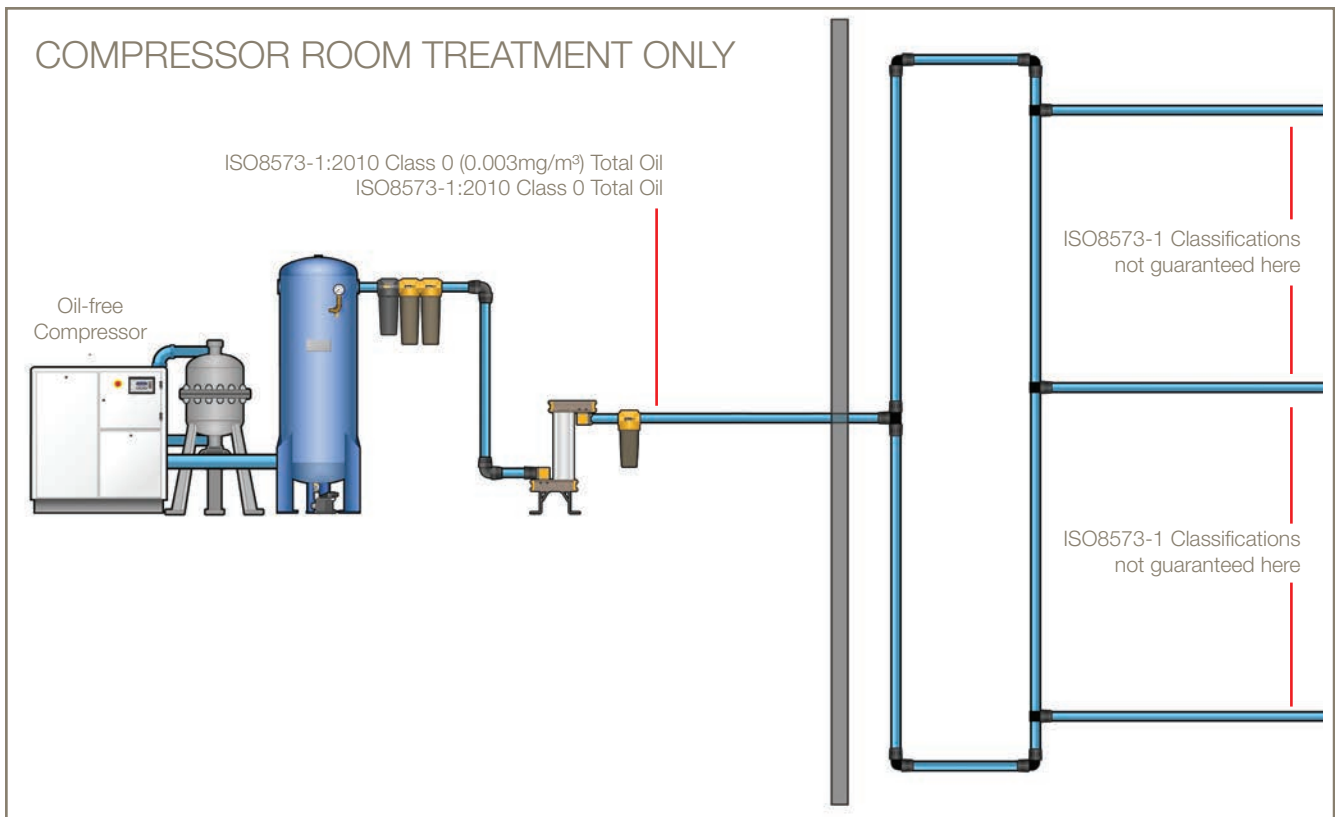
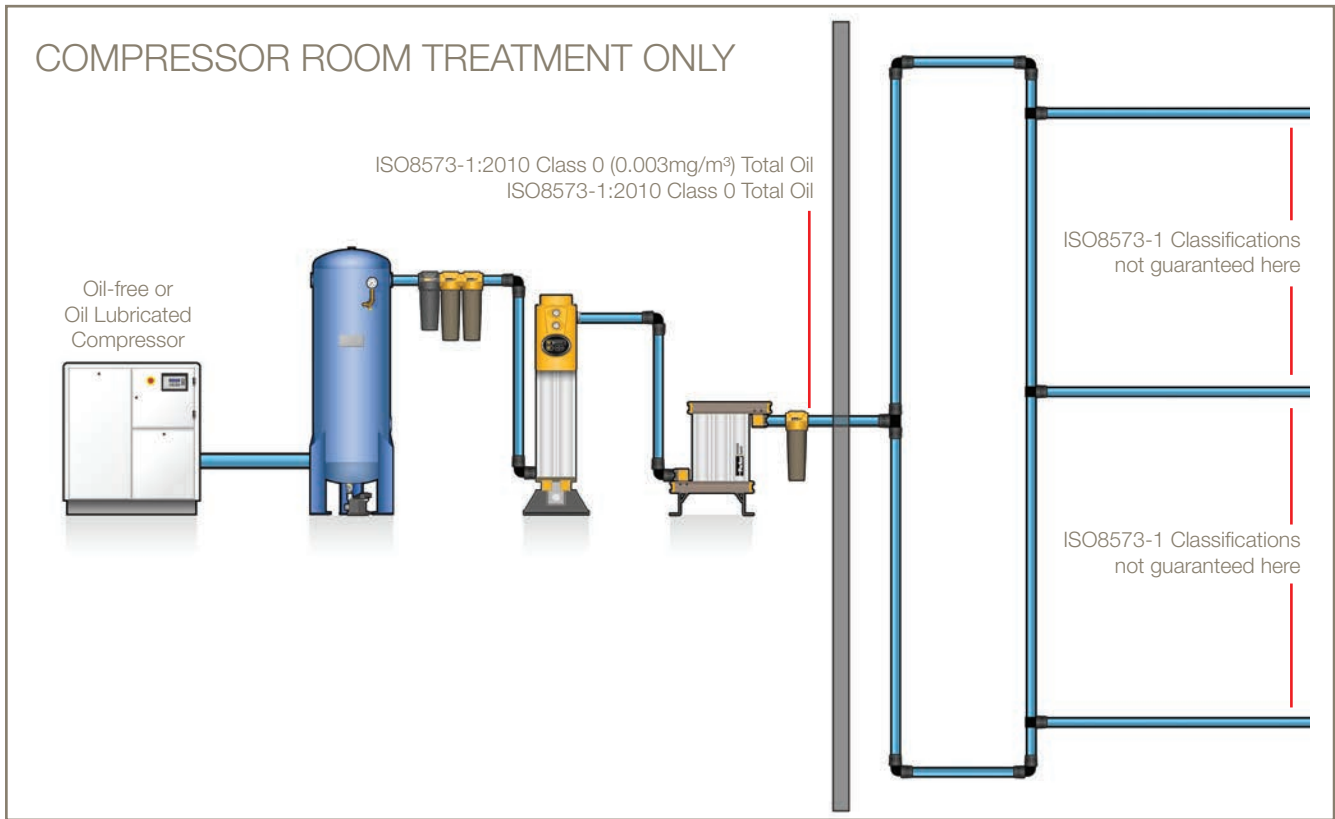



# Oil-free Compressors and Heat of Compression (HOC) Dryers

How do they differ from traditional compressed air dryers?

## Drying Compressed Air

Oil-free compressors are often supplied with an integrated heat-of-compression (HOC) dryer. To understand this technology, one must first understand the need for water vapor reduction, what “dewpoint” is, how dewpoint can affect the growth of micro-organisms and the difference between constant dewpoint and dewpoint suppression.

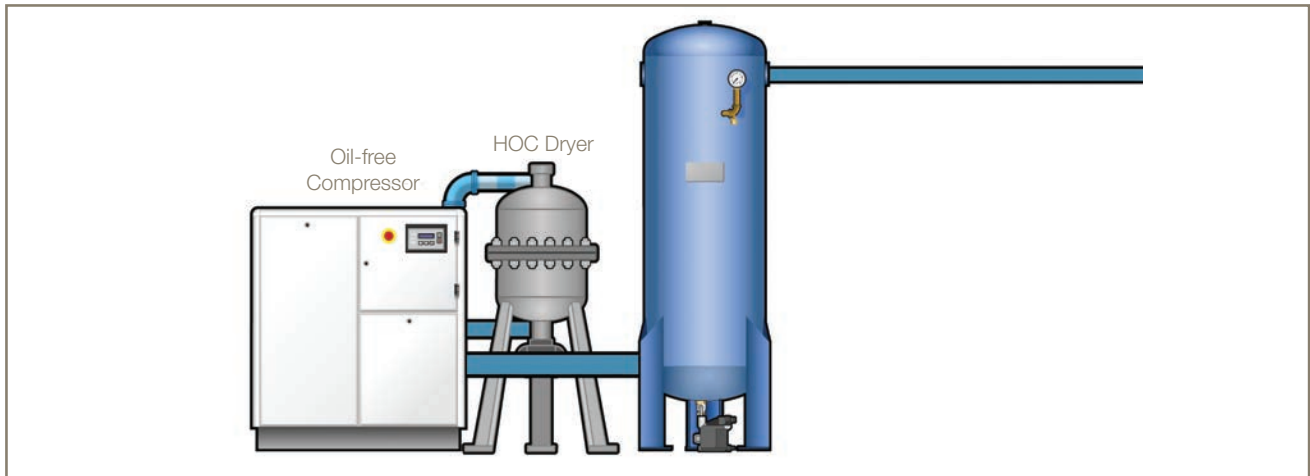

## Water, Water, Everywhere . . .

Compressed air is wet. Untreated, compressed air entering the distribution piping system contains liquid water, water aerosols and is 100% saturated with water vapor. Water is the most problematic of all compressed air contaminants. It not only causes damage through corrosion, more seriously; wet air promotes the growth of micro-organisms which in turn can harm those working near operational pneumatic equipment and contaminate products and processes.

Controlling the amount of water in the compressed air is therefore of paramount importance and today, almost all compressed air systems will employ purification equipment to treat the compressed air for contaminants. For liquid reduction, a water separator will be used, for the treatment of aerosols of water and oil (plus particulates), coalescing filters will be fitted and to reduce the levels of water vapor, a compressed air dryer will be installed.



### How Dry is My Compressed Air?

The 'dryness' of the air treated by a compressed air dryer (the dryer's performance) is stated as its outlet 'dewpoint'. Dewpoint refers to the temperature at which condensation will occur and is expressed as a temperature.

Pressure dewpoint (abbreviated to PDP) refers to a dewpoint measurement of compressed air taken at the system operating pressure while atmospheric dewpoint (ADP) refers to the dewpoint of compressed air after it has been expanded back to atmospheric pressure.

Although expressed as a temperature, this figure is not the actual air temperature. For example: Compressed air can have an actual temperature of 95°F (35°C) while having a pressure dewpoint of -40°F (-40°C).



### Compressed Air Dewpoint and Microbiological Growth

Unknown to many users, compressed air systems contain huge amounts of microbiological contamination and the warm, wet compressed air system is an ideal environment for growth. Having the right compressed air dewpoint will inhibit the growth of micro-organisms and thus allow point of use filtration to be effective in reducing concentrations to acceptable levels or provide totally sterile air.

It is for this reason, documents such as the British Compressed Air Society (BCAS) Food and Beverage Grade Compressed Air Best Practice Guideline 102 recommends a pressure dewpoint of  $\leq -40^{\circ}\text{F}$  for direct contact applications.



# Constant Dewpoint or Dewpoint Suppression

## What is the difference?

There are many types of compressed air dryers available. While it is commonly known that different technologies deliver different outlet dewpoints (for example, refrigeration dryers typically deliver outlet dewpoints of above 37°F (3°C) and adsorption dryers dewpoints below 32°F (0°C)), they also differ in the consistency of the outlet dewpoint delivered. Manufacturers design dryers to deliver either a constant outlet dewpoint (which has little variation), or a dewpoint suppression (with large dewpoint variations).

### Constant Dewpoint

To deliver a constant outlet dewpoint, a dryer is first 'sized' to match worst case inlet and ambient conditions of the user's site (maximum water vapor loading). The important factors for sizing a dryer are maximum inlet temperature (in summer), minimum inlet pressure, and maximum inlet flow rate. Sizing the adsorption bed using these parameters ensures the adsorption bed is large enough and capable of handling the maximum water vapor loading of the system while being able to deliver a consistent outlet dewpoint.

A dryer delivering a constant outlet dewpoint will see small fluctuations, but will always deliver a minimum pressure dewpoint. For example, if an adsorption dryer is selected to deliver a  $\leq -40^\circ\text{F}$  ( $-40^\circ\text{C}$ ) PDP, then  $-40^\circ\text{F}$  PDP will be the worst dewpoint delivered. Typically, the outlet dewpoint will fluctuate between say  $-58^\circ\text{F}$  ( $-50^\circ\text{C}$ ) and  $-40^\circ\text{F}$  and this is due to the way the adsorption dryer operates.

Initially, dewpoint will be low ( $-58^\circ\text{F}/-50^\circ\text{C}$ ) as compressed air flows over the newly regenerated adsorbent material after column changeover, dropping towards the minimum acceptable dewpoint ( $-40^\circ\text{F}$  in this case) as the adsorbent material adsorbs the water vapor in the air. The dryer will change automatically from the active, on-line column to the regenerated column to always achieve the  $-40^\circ\text{F}$  ( $-40^\circ\text{C}$ ) PDP.

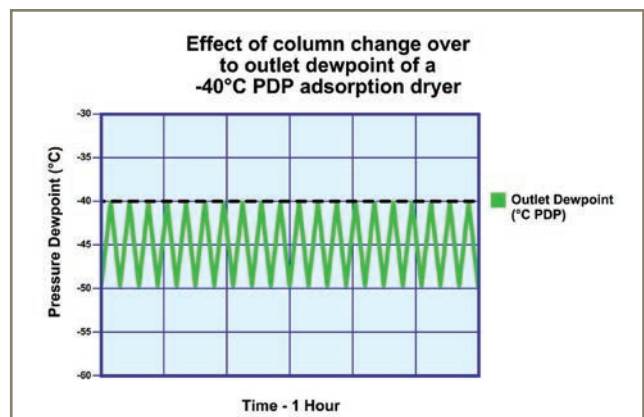
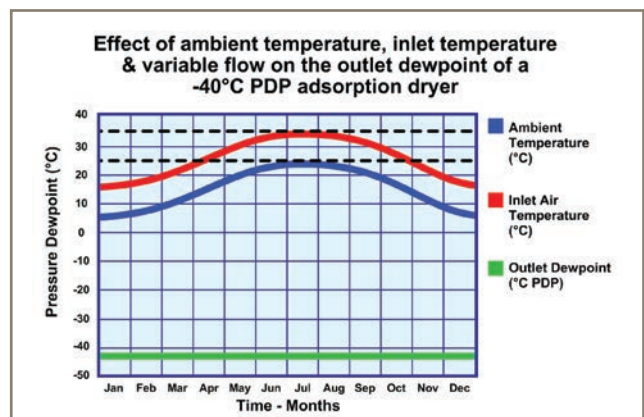



## Dewpoint Suppression

There are also dryers available that are designed to provide dewpoint suppression. These are typically not sized to match ambient conditions, which in the case of adsorption dryers, results in a smaller amount of adsorption material for drying.

The advantage of not sizing for all conditions is that they can be fitted in places where larger, constant dewpoint dryers cannot (for example, railway braking systems). The disadvantage is that the outlet dewpoint delivered by a suppression dryer can vary significantly.

Dewpoint suppression dryers are affected by changes in ambient air temperature and inlet temperature (water vapor loading).

If a dryer is designed to provide a dewpoint suppression of  $-4^{\circ}\text{F}$  ( $-20^{\circ}\text{C}$ ), then it will reduce the dewpoint to 68 degrees below the compressed air temperature. This figure of  $-4^{\circ}\text{F}$  should not be confused as a constant outlet dewpoint as it often is.

**Example:** If the ambient temperature in summer is  $77^{\circ}\text{F}$  ( $25^{\circ}\text{C}$ ) and the compressed air temperature into the dryer is  $95^{\circ}\text{F}$  ( $35^{\circ}\text{C}$ ), then the dewpoint delivered from a  $-4^{\circ}\text{F}$  dewpoint suppression dryer will be  $+59^{\circ}\text{F}$  ( $15^{\circ}\text{C}$ ) not  $-4^{\circ}\text{F}$  as is often assumed.

Typical examples of drying technologies providing dewpoint suppression are membrane dryers, heatless dewpoint suppression dryers and heat-of-compression (HOC) dryers.

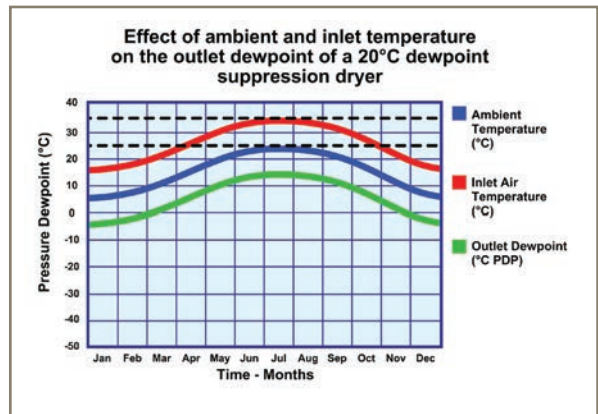
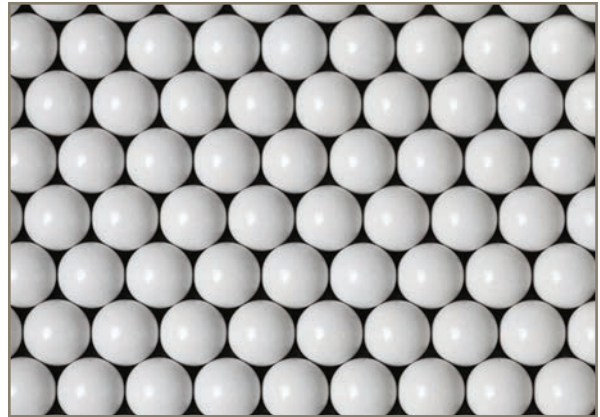

# Oil-free Compressors and Heat of Compression (HOC) Dryers

How does the delivered dewpoint differ from traditional compressed air dryers?

## Heat of Compression (HOC) Dryers

HOC dryers are designed to take advantage of the high compression temperatures found when operating an oil-free screw compressor.

This type of dryer is marketed as low energy consumption dryers, as it uses the heat generated during the compressors process to regenerate the adsorbent material. Unfortunately, the air quality (dewpoint) delivered by the HOC technology is often misinterpreted. Additionally, the HOC dryers ability to deliver a constant outlet dewpoint is often omitted during discussions with users.

HOC dryers do not always look the same as traditional dryers, The construction of HOC dryers are typically based around a traditional style “twin tower” type dryer (with 2 main variants) or more commonly based upon a “drum” of adsorbent material which either rotates or has rotating drying sectors (typically 3 variants available). No matter the construction method, the following should points always be considered before selecting an HOC dryer.

## HOC Dryers and Outlet Dewpoint

Unlike traditional standalone dryers, HOC dryers are not typically sized to match ambient conditions, therefore their adsorbent beds are significantly smaller than a constant dewpoint dryer (some marketing claims state only 5 to 10% of an equivalent traditional dryer).

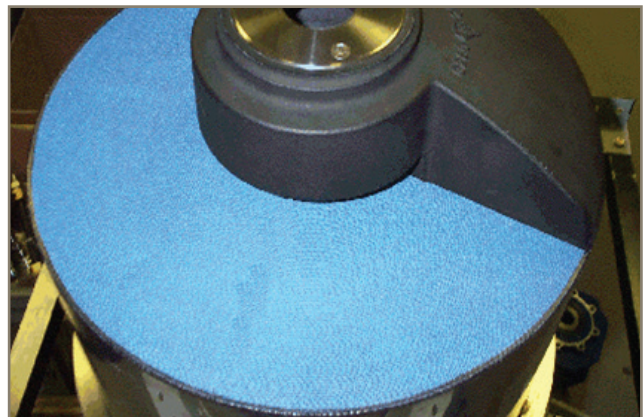
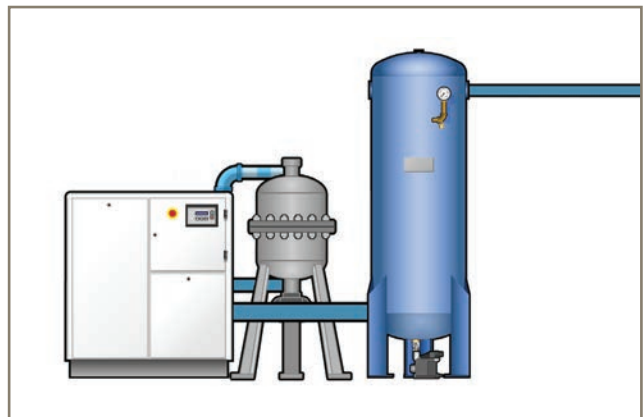
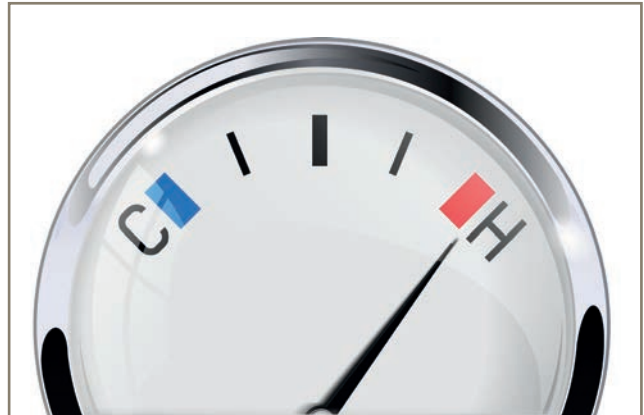



Ambient temperature and relative humidity fluctuates day to night and all throughout the year. As ambient temperatures increase, so does the compressed air inlet temperature to the dryer. Higher inlet temperatures result in a higher water vapor loading. If the dryer adsorption bed has not been sized for the worst case water vapor loading, it will have insufficient adsorption capacity and the dryer will be unable to maintain a constant outlet dewpoint.



HOC dryers also require the compressor to be operating at maximum flow to generate the heat required to regenerate the adsorbent material. Compressor loading varies constantly (especially with low energy variable speed compressors). Without full heat for regeneration, the adsorption material is not fully dried during regeneration. If the adsorption material is not completely regenerated, the outlet dewpoint will naturally suffer.

Changes in ambient temperature also affect the ability of the regeneration cooler to cool the compressed air after regeneration and before it is dried. As this air is saturated, it will place increased water vapor loading on the adsorbent material, again varying the outlet dewpoint.

The ability of the adsorbent material to adsorb water vapor is reduced significantly with high temperature and typically on the drum style of HOC dryer the hot regeneration sector rotates straight into the drying sector without prior cooling. As the regeneration temperature is high, the adsorbent material will not adsorb water vapor until sufficiently cooled by the incoming compressed air, reducing the available amount of effective adsorbent and affecting the outlet dewpoint.

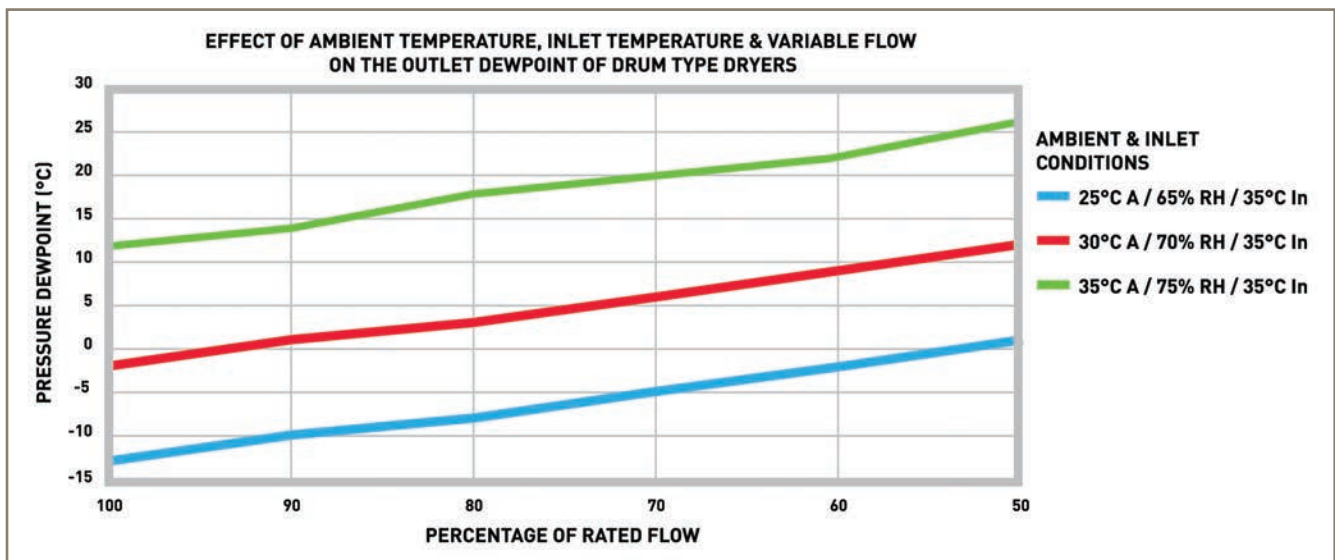

### HOC Dryer Outlet Dewpoint

The combination of smaller adsorbent bed, constantly changing compressor duty and inefficient cooling results in a constantly changing outlet dewpoint, i.e. Dewpoint suppression, not constant dewpoint.

## Why choose a dryer with a constant outlet dewpoint?

Critical applications in the food, beverage and pharmaceutical industries, for example those with direct contact between compressed air and ingredients, finished products, manufacturing equipment or packaging will require either sterility or a degree of control over the growth of micro-organisms.

It has been found that compressed air with a pressure dewpoint below  $-15^{\circ}\text{F}$  ( $-26^{\circ}\text{C}$ ) will inhibit the growth of micro-organisms and therefore a guaranteed minimum outlet dewpoint is always required. It is for this reason that documents published by the British Compressed Air Society (Food and Beverage Grade Compressed air - Best practice guideline 102) and EHEDG recommend a pressure dewpoint of  $\leq -40^{\circ}\text{F}$  ( $-40^{\circ}\text{C}$ ) PDP.

With the varying dewpoint delivered by a dewpoint suppression or HOC dryer, a dewpoint sufficient to slow or inhibit the growth of micro-organisms cannot be guaranteed.



# How do I know if the dryer I have is a constant dewpoint or dewpoint suppression dryer?

Unfortunately, manufacturers do not always state if their dryer delivers a constant outlet dewpoint or a suppression dewpoint. It is often assumed that if a manufacturer states a dewpoint that it is delivered all the time, but unfortunately this is not always the case.

One easy way is to see if the dryer manufacturer states a dewpoint classification in accordance with ISO8573-1 for water. ISO8573-1 is the International Standard relating to compressed air purity (quality) and includes 6 dewpoint classifications in bands from -94°F to +50°F (-70° to 10°C).

ISO8573-1:2010 Classification for Water	Pressure Dewpoint	Dewpoint Band
<b>Class 1</b>	≤ -94°F (-70°C) PDP	-112° to -94°F (-80° to -70°C)
<b>Class 2</b>	≤ -40°F (-40°C) PDP	-92° to -40°F (-69° to -40°C)
<b>Class 3</b>	≤ -4°F (-20°C) PDP	-38° to -4°F (-39° to -20°C)
<b>Class 4</b>	≤ +37°F (+3°C) PDP	-2° to +37°F (-19° to +3°C)
<b>Class 5</b>	≤ +45°F (+7°C) PDP	+39° to +45°F (+4° to +7°C)
<b>Class 6</b>	≤ +50°F (+10°C) PDP	+46° to +50°F (+8° to +10°C)

For a manufacturer to state a dryer delivers an ISO8573-1 classification, the dryer must always deliver the outlet dewpoint within the band of one classification.

A constant outlet dewpoint dryer will typically state an ISO8573-1 classification as the dewpoint can clearly fall within a defined band, whereas a dewpoint suppression dryer or HOC dryer typically does not state an ISO8573-1 classification as the outlet dewpoint varies too greatly.

## Verifying Dewpoint

Installing a dryer fitted with a dewpoint hygrometer or using a separate dewpoint hygrometer downstream of the dryer will allow the user to easily verify that the dryer is delivering the agreed outlet dewpoint.

# It's not all about oil

Oil in a compressed air system is not the biggest concern for users. There are a minimum of 10 contaminants found in a compressed air system that require treatment and they come from four different sources (not solely from the compressor).

## Contaminants and sources in a compressed air system

### Atmospheric contamination entering the compressor

- Micro-organisms
- Water Vapor
- Atmospheric Particulates
- Oil Vapor (hydrocarbons and VOC)
- Other Gaseous Contaminants



Contaminant Source No. 1  
Ambient Air

### Contamination introduced by the compressor

- Water Aerosols
- Condensed Liquid Water
- Liquid Oil and Oil Aerosols
- Oil Vapor



Contaminant Source No. 2: The Air Compressor

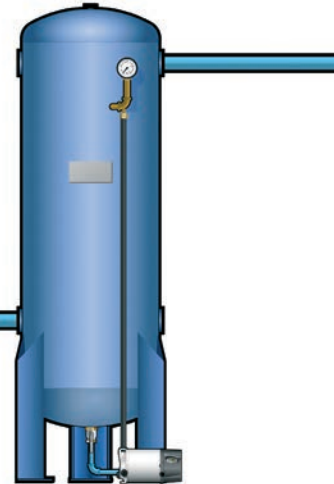

Contaminant Source No. 3: The Air Receiver

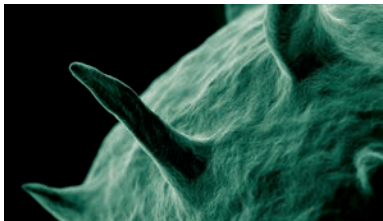

### Micro-organisms

Ambient air can contain up to 100 million micro-organisms per cubic meter. Due to their small size, bacteria, viruses, fungi, yeast and spores will all pass through the intake filter and into the compressed air system.

The warm, moist environment inside the air receiver and distribution piping provides an ideal environment for their rapid growth. Microbial growth is significant in compressor condensate and care must be taken when discharging condensate.

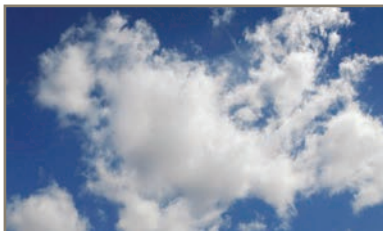

### Water vapor

Water enters the compressed air system as a vapor (gas). The ability of air to hold water vapor is dependent upon its pressure and its temperature. The higher the temperature, the more water vapor can be held by the air,

the higher the pressure, a greater amount of water vapor is squeezed out. As ambient air is compressed, the temperature of the air increases significantly, allowing the heated air to easily retain all of the water vapor entering the compressor.



### Oil vapor

Vehicle emissions and inefficient industrial processes lead to oil vapor contamination in the ambient air. Typical concentrations in ambient air can seem low (between 0.05 and 0.5mg per cubic meter), however values measured in compressed air increase significantly after

compression when contaminants become concentrated. Once in a compressed air system, oil vapor can taint ingredients, finished products, and packaging with an oily smell. Cooling also causes oil vapor to condense into liquid oil and form oil aerosols.



### Atmospheric particulate

Ambient air in industrial and urban environments will typically contain between 140 and 150 million dirt particles in every cubic meter. As 80% of these

particles are less than 2 microns in size, they are therefore too small to be captured by the compressor air intake filter and will travel unrestricted into the compressed air system.



Ambient air is laden with many unseen contaminants which are drawn into the compressor intake. Once in the compressed air system, many of the hazards found in ambient air change phase, leading to the creation of additional contaminants.

**Contamination introduced by the air receiver and distribution piping**

- Rust
- Pipescale

**Total contamination entering the compressed air distribution system**

- Micro-organisms
- Water Vapor
- Atmospheric Particulates
- Oil Vapor (hydrocarbons and VOC)
- Water Aerosols
- Condensed Liquid Water
- Liquid Oil
- Oil Aerosols
- Rust
- Pipescale

**Contaminant Source  
No. 4  
The Distribution Piping**



**Liquid water and water aerosols**

After compression, compressed air is cooled to a usable temperature by an aftercooler. This cooling reduces the air's ability to retain water vapor, resulting in condensation of water vapor into liquid water. The presence of liquid also causes aerosols to be formed.

Aftercoolers typically incorporate a water separator to reduce the amount of liquid entering the compressed air system (these do not remove 100% of the condensed liquid and have no effect on aerosols).

The air leaving the aftercooler and entering the compressed air system is now 100% saturated with water vapor. Any further cooling of the compressed air will result in more water vapor condensing into liquid water and the generation of more aerosols.

Condensation occurs at various stages throughout the system as the air is cooled further by the air receiver, the distribution piping and the expansion of air in valves, cylinders, and production equipment.



**Liquid oil and oil aerosols**

As with water, oil vapor drawn in with the ambient air is cooled and condensed within the aftercooler leading to the formation of liquid oil and oil aerosols (even with oil-free compressors) which carry downstream. The majority of air compressors in use today use oil in their compression stage for sealing, lubrication, and cooling.

Even though the oil is in direct contact with the air as it is compressed, due to the efficiency of modern air/oil separators built into the compressor, only a small proportion of this lubricating oil is carried over into the compressed air system as a liquid or aerosol (typically no more than 5mg/m<sup>3</sup> for a well maintained screw compressor) or as oil vapor.



**Rust and pipescale**

Rust and pipescale can be directly attributed to the presence of water in the compressed air system and is usually found in air receivers and distribution piping. Over time, the rust and pipescale breaks away to cause damage or blockage in production equipment which

can also contaminate final product and processes. Rust and pipescale problems often increase for a period of time after the installation of dryers into older piping systems which were previously operated with inadequate or with no purification equipment.



# Contaminant Reduction

To operate any compressed air system safely and cost effectively, contamination must be reduced to acceptable limits.

Poor compressed air quality and failure to control contamination can cause numerous problems for an organization, many of which are not immediately associated with contaminated compressed air.

## Product

- Contaminated raw materials
- Contaminated products
- Contaminated packaging
- Spoiled products

## Consumer

- Potentially unwell/seriously ill consumers
- Unhappy customers

## Manufacturer

- Brand damage
- Legal actions
- Financial loss
- Potential imprisonment (in certain industries)

## Manufacturing Process

- Inefficient production processes
- Reduced production efficiency
- Increased manufacturing costs
- Failed quality audits (in certain industries)

## Compressed Air System

- Growth, storage and distribution of microbiological contamination
- Corrosion within storage vessels and the distribution system
- Contaminated/damaged production equipment
- Blocked or frozen valves and cylinders
- Premature unplanned desiccant changes for adsorption dryers
- High operational and maintenance costs

## Contaminant control

Ensuring effective control of compressed air contamination, requires a number of purification technologies. To many compressed air users, the realization that there are ten major contaminants in a compressed air system is somewhat of a surprise. It is often thought that only three contaminants are present (dirt/water/oil), however as those contaminants can be found in many phases, they therefore require a specific purification technology for efficient reduction.

The table below highlights filtration and drying technologies that comprise the purification system and the contaminants they reduce.

Purification Technologies	Contaminants								
	Atmospheric Particles	Rust and Pipescale	Micro-organisms	Liquid Water	Water Aerosol	Water Vapor	Liquid Oil	Oil Aerosol	Oil Vapor
Water Separator				●			●		
Coalescing Filters	●	●	●		●			●	
Adsorption Filters									●
Dryer						●			
Dry Particulate Filters	●	●	●						
Sterile Filters*			●						



A solution for every contaminant

## Compressor Room

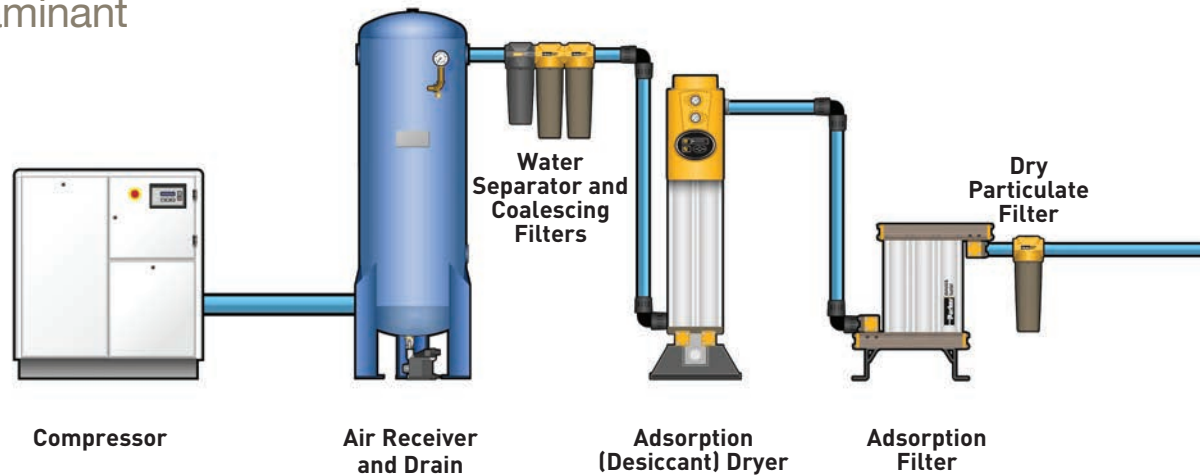

### Water separators

Although called water separators, they reduce the content of all liquids at the point of installation. Liquid in a compressed air system is usually a mixture of oil and water (even when using an oil-free compressor).

Water separators are usually the first piece of purification equipment installed downstream of an aftercooler or wet air receiver and should be used to protect coalescing filters from liquid contamination. They will only reduce liquids and will have no effect on water or oil in an aerosol or vapor phase.

### Coalescing filters

When considering purification equipment, coalescing filters are vital for the cost effective operation of any compressed air system, regardless of the type of compressor installed.

A purification system will normally consist of two coalescing filters installed in series to remove water aerosols, oil aerosols, atmospheric particulate, micro-organisms, rust and pipescale.

### Compressed air dryers

Water vapor is water in a gaseous form and will pass through water separators and coalescing filters just as easy as the compressed air. Water vapor is therefore removed from compressed air using a dryer. The water vapor removal efficiency of a dryer (its performance) is expressed as a Pressure Dewpoint or PDP.

- Dewpoint refers to the temperature at which condensation will occur.
- Pressure Dewpoint or PDP refers to the dewpoint of air above atmospheric pressure.
- Dewpoint is expressed as a temperature (however this is not the temperature of the air).
- Compressed air with a PDP of  $-4^{\circ}\text{F}$  ( $20^{\circ}\text{C}$ ), would need the temperature to drop below  $-4^{\circ}\text{F}$  for any water vapor to condense into a liquid.
- A PDP of  $-40^{\circ}\text{F}$  ( $-40^{\circ}\text{C}$ ) is recommended for all food, beverage and pharmaceutical applications where air is directly or indirectly contacting production equipment, ingredients, packaging or finished products because a PDP better than  $-15^{\circ}\text{F}$  ( $-26^{\circ}\text{C}$ ) will not only stop corrosion, it will also inhibit the growth of micro-organisms.

### Adsorption dryer

Adsorption dryers reduce water vapor in compressed air by passing air over a regenerative desiccant material which strips the moisture from the air. This method of drying is extremely efficient. A typical pressure dewpoint specified for an adsorption dryer is  $-40^{\circ}\text{F}$  as it not only prevents corrosion, more importantly it also inhibits the growth of micro-organisms.

There are many types of adsorption dryer available, and while they all use the same principle to remove moisture from compressed air, there are a number of different methods used for the regeneration of the wet adsorbent material.

For food and beverage applications, care should be taken when selecting an adsorption dryer as some regeneration methods used may have an impact on the contamination levels of the compressed air.

### Refrigeration dryers (not shown)

Refrigeration dryers work by cooling the compressed air further and condensing the water vapor into a liquid for removal by a water separator.

Refrigeration dryers are limited to positive pressure dewpoint to prevent freezing of the condensed liquid, and are typically used for general purpose industrial applications with indoor piping.

They should not be used in any facility where piping is installed in ambient temperatures below the dryer dewpoint, i.e. systems with external air receivers or piping.

### Adsorption filter

To ensure 'technically oil-free air', adsorption filters are employed which utilise a large bed of activated carbon adsorbent for the effective reduction of oil vapor. The combination of coalescing filters and adsorption filters will provide compressed air to the highest air quality classifications of ISO8573-1, the international standard for compressed air quality.



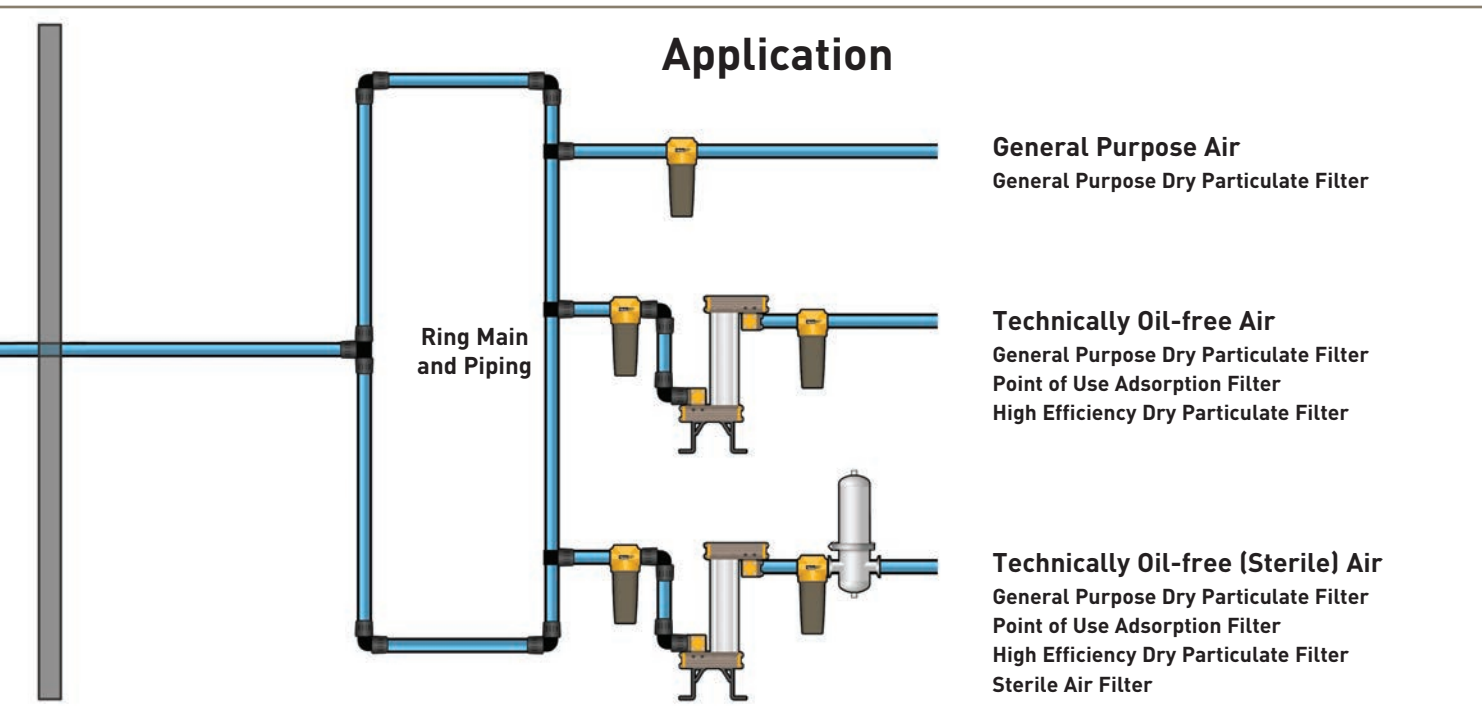

#### Dry Particulate filters

Dry particulate filters provide identical particulate removal performance to the equivalent grade coalescing filter. Relying on mechanical filtration techniques, high efficiency dry particulate filters can provide particle reduction down to 0.01 micron with a removal efficiency of 99.9999%. When coupled with a -40°F Pressure Dewpoint, to inhibit and control the growth of micro-organisms, they can provide significant reduction of microbiological contaminants.

#### Sterile filters

Absolute (100%) removal of solid particulates and micro-organisms is performed by a sieve retention or membrane filter. They are often referred to as sterile air filters as they also provide sterilized compressed air. Filter housings are manufactured from stainless steel to allow for in-situ steam sterilisation of both the filter housing and element. It is important to note that the piping between the sterile filter and the application must also be cleaned and sterilized on a regular basis.

#### Important Notes:

As adsorption or refrigeration dryers are only designed to reduce water vapor and not water in a liquid or aerosol form, they require the use of coalescing filters to work efficiently.

Suppliers of oil-free compressors will often state that one of the coalescing filters is a particulate filter and the other is an oil removal filter, therefore, in oil-free compressor installations, there is no need for the oil removal filter. This is not correct.

In reality, both filters remove exactly the same contaminants. The first filter is a general purpose filter which protects the second, high efficiency filter from heavy contamination.

Omitting one of the filters in the belief that it is an oil removal filter will result in poor air quality due to contaminant bypass (carryover), high operational costs due to the pressure loss across the filter and more frequent filter element changes. Most importantly, omitting one of the filters will also invalidate performance guarantees.

The dual coalescing filter installation ensures a continuous supply of high quality compressed air with the additional benefits of lower operational costs and minimal maintenance compared to a single high efficiency filter.

Refrigeration dryers are not recommended for food and beverage applications where compressed air comes into direct contact (or in-direct contact) with ingredients, production equipment, finished products, or packaging, as the dewpoints provided are unable to inhibit microbiological growth.

Refrigeration dryers are commonly available with quoted dewpoints of +31°F, +45°F or +50°F, however care must be taken when selecting this type of dryer as unlike adsorption dryers, the dewpoint quoted is not always provided constantly. Integrated dewpoint meters are typically just temperature gauges and do not indicate a true pressure dewpoint, which is often in the range of 46°F to 59°F [8°-15°C].

# FAQs and What-If Scenarios

<b>Does the air compressor use oil in the compression stage(s)?</b>	
Oil Lubricated	Yes
Oil-free	No

<b>Does the air compressor use oil to lubricate bearings/gearboxes?</b>	
Oil Lubricated	Yes
Oil-free	Yes

<b>Can the air compressor be operated with food grade lubricant?</b>	
Oil Lubricated	Yes
Oil-free	No

<b>Can the compressed air be contaminated with oil from the crank case breather?</b>	
Oil Lubricated	Not Applicable
Oil-free	Yes

<b>Is the compressor fitted with an air/oil separator?</b>	
Oil Lubricated	Yes
Oil-free	No

<b>If the air/oil separator fails, can oil be carried downstream?</b>	
Oil Lubricated	Yes
Oil-free	Not Applicable

<b>Does the air compressor have seals stop the compressed air being contaminated with lubricating oil?</b>	
Oil Lubricated	Not Applicable
Oil-free	Yes

<b>If the seals fail, can oil be carried downstream?</b>	
Oil Lubricated	Not Applicable
Oil-free	Yes

<b>If failure allows liquid oil downstream, what is the first measure to prevent contamination reaching processes/products/packaging?</b>	
Oil Lubricated	Air Receiver + Condensate Drain
Oil-free	Air Receiver + Condensate Drain



# FAQs and What-If Scenarios

Does the installation typically include additional downstream purification?	
Oil Lubricated	Yes
Oil-free	No

What additional downstream purification is included?	
Oil Lubricated	Water Separator General Purpose Coalescing Filter High Efficiency Coalescing Filter Adsorption Dryer Dry Particulate Filter Oil Vapor Reduction Filter
Oil-free	Not Applicable

In the event of a failure resulting in bulk oil leaving the compressor, what contamination will the purification equipment installed downstream of the air receiver reduce?	
Oil Lubricated	Water separator = Liquid Oil and Liquid Water General Purpose Coalescing Filter = Oil Aerosols down to 0.5mg/m <sup>3</sup> High Efficiency Coalescing Filter = Oil Aerosols down to 0.01 mg/m <sup>3</sup> Adsorption Dryer = Will stop aerosols/liquid oil but will require service afterwards Dry Particulate Filter = Will also coalesce liquid oil if still present Oil Vapor Reduction Filter = Oil vapor ≤0.003mg/m <sup>3</sup>
Oil-free	None, contamination will travel downstream

Is sufficient purification equipment included to treat oil vapor in the ambient air which is drawn into the compressor intake and concentrated during the compression process?	
Oil Lubricated	Yes
Oil-free	No

Does the typical installation provide 'Technically Oil-free Air' at point of use?	
Oil Lubricated	Yes, with the additional purification equipment listed (≤0.003mg/m <sup>3</sup> of oil in accordance with ISO 8573-1 Class 0 for Total Oil)
Oil-free	No

Does the compressor package include an integrated dryer for water vapor reduction or is the dryer specified external?	
Oil Lubricated	External
Oil-free	Integrated

# FAQs and What-If Scenarios

<b>Is the dewpoint delivered by the dryer constant or a suppression dewpoint?</b>	
<b>Oil Lubricated</b>	Constant (typically $\leq -40^{\circ}\text{F}$ ( $-40^{\circ}\text{C}$ ) PDP with option for $\leq -94^{\circ}\text{F}$ ( $-70^{\circ}\text{C}$ ) PDP or $\leq -4^{\circ}\text{F}$ ( $-20^{\circ}\text{C}$ ) PDP)
<b>Oil-free</b>	Suppression, large dewpoint changes with compressor loading and changes to ambient temperature/RH

<b>Is the delivered dewpoint affected by changes in ambient temperature and relative humidity?</b>	
<b>Oil Lubricated</b>	No
<b>Oil-free</b>	Yes, changes as ambient temperature and RH changes

<b>Is the delivered dewpoint sufficient to inhibit the growth of micro-organisms (<math>&lt; -15^{\circ}\text{F}/-26^{\circ}\text{C}</math> PDP)?</b>	
<b>Oil Lubricated</b>	Yes
<b>Oil-free</b>	No

<b>Does the dryer require the compressor to operate for regeneration?</b>	
<b>Oil Lubricated</b>	No, dryer regeneration is independent of compressor usage
<b>Oil-free</b>	Yes, or dewpoint will be affected

# Other Gaseous Contaminants of Concern

## Sulfur Dioxide (SO<sub>2</sub>)

Sulfur Dioxide is produced as a by-product of the burning of fossil fuels and is also present in the ambient air drawn into the compressor intake. The oil in an oil lubricated compressor also provides additional benefits as it can also neutralize sulfur dioxide (SO<sub>2</sub>) drawn in through the compressor intake.

In an oil-free compressor, there is no oil to neutralize harmful vapors such as SO<sub>2</sub>. As the intercooler and aftercooler in an oil-free compressor condenses water vapor into liquid water, the SO<sub>2</sub> from the air reacts with condensed water vapor to form sulfurous acid (like acid rain). Measurements from compressed air systems show that the resulting condensate has a pH value between 3 and 6, attacking the downstream air receivers, piping, and purification equipment more aggressively than condensate from a lubricated compressor.

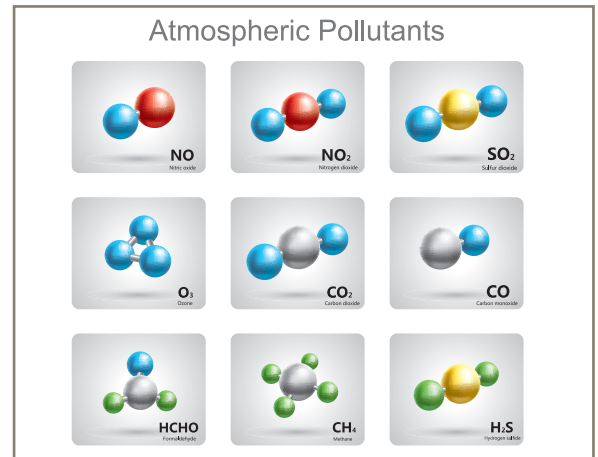

## Ozone

Another factor to consider is ozone. Oil-free screw compressors, while using oil to lubricate bearings and gearboxes, do not inject oil into the compression stage for cooling. This means the temperature during compression becomes extremely high (above the safe operating temperature of many materials), therefore they typically compress in two stages, unlike an oil lubricated machine which does it in a single stage. An intercooler is placed between the first and second stages to help reduce the temperature, however the compressed air temperature can be in the range of 350°F – 392°F (177°C-200°C) (on oil lubricated screw machines, the compressed air temperature is typically around 176°F (80°C)).

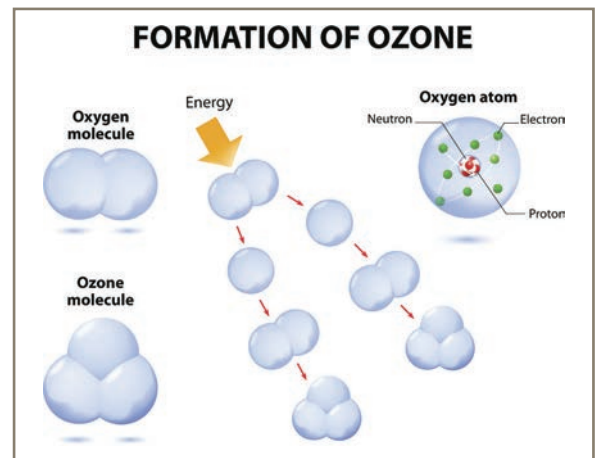

The compression process, its associated high temperature, oxygen, and the presence of VOC can create ozone which preferentially and sacrificially attacks certain organic functional groups. Without oil being present in the gas stream, such as in the oil-free machine, it is difficult for the ozone to react and its concentration to reduce and therefore ozone levels in the compressed air discharged by an oil-free compressor are likely remain significantly higher than those in an oil lubricated system. The ozone therefore enters the distribution piping downstream of the compressor, often damaging seals, gaskets, valves, and purification equipment.

Large bed, activated carbon adsorption filters used for the reduction of oil vapor have the advantage of not only reducing the levels of oil vapor in the compressed air, they will also reduce ozone levels present.

# Summary

- Ambient air may look clean but is not.
- Ambient air is not 'oil-free'.
- In addition to water vapor, ambient air contains hydrocarbons, volatile organic compounds, and other gaseous contaminants such as NO<sub>x</sub>, SO<sub>x</sub>, CO, CO<sub>2</sub>. (see Appendix 3 for further information on contaminants and sources).
- Ambient air contains oil vapor, with typical levels between 0.05 mg/m<sup>3</sup> and 0.5 mg/m<sup>3</sup> (this can be higher in places).
- Air quality reports from DEFRA and other global testing corroborates this.
- These compounds are drawn into the compressor intake.
- As the ambient air is compressed, the hydrocarbons, VOC, and other contaminants are concentrated.
- As the ambient air is not "oil-free", oil-free compressors are unable deliver "oil-free" air without the addition of downstream filtration for the reduction of liquid oil, oil aerosols, and oil vapor.
- Many oil-free compressors still use oil for lubrication of bearings and gearboxes
- This oil can also pass into the flow of compressed air from damaged seals and from vapors released by the crank case breather as the compressor operates.
- The practice of omitting filtration on the belief that an oil-free compressor is delivering oil-free air is incorrect.
- The purification equipment required downstream of an oil-free compressor is identical to that of an oil lubricated compressor.
- To accurately test for oil in a compressed air system, the methodology and equipment shown in ISO8573 Parts 2 (oil aerosol) and Part 5 (oil vapor) should be used.
- Ozone can be generated when oil-free compressors are used.
- The oil in an oil lubricated compressor can reduce certain gaseous contaminants and prevent the formation of ozone.
- The condensate from an oil-free compressor can be more aggressive, for example, Sulfur Dioxide from the ambient air mixing with condensed water vapor can produce sulfurous acid.





# Worldwide Filtration Manufacturing Locations

## North America

### Compressed Air Treatment

#### Industrial Gas Filtration and Generation Division

Lancaster, NY  
716 686 6400  
[www.parker.com/igfg](http://www.parker.com/igfg)

Haverhill, MA  
978 858 0500  
[www.parker.com/igfg](http://www.parker.com/igfg)

### Engine Filtration

#### Racor

Modesto, CA  
209 521 7860  
[www.parker.com/racor](http://www.parker.com/racor)

Holly Springs, MS  
662 252 2656  
[www.parker.com/racor](http://www.parker.com/racor)

### Hydraulic Filtration

#### Hydraulic & Fuel Filtration

Metamora, OH  
419 644 4311  
[www.parker.com/hydraulicfilter](http://www.parker.com/hydraulicfilter)

Laval, QC Canada  
450 629 9594  
[www.parkerfarr.com](http://www.parkerfarr.com)

Velcon  
Colorado Springs, CO  
719 531 5855  
[www.velcon.com](http://www.velcon.com)

### Process Filtration

#### domnick hunter Process Filtration SciLog

Oxnard, CA  
805 604 3400  
[www.parker.com/processfiltration](http://www.parker.com/processfiltration)

### Water Purification

#### Village Marine, Sea Recovery, Horizon Reverse Osmosis

Carson, CA  
310 637 3400  
[www.parker.com/watermakers](http://www.parker.com/watermakers)

## Europe

### Compressed Air Treatment

#### domnick hunter Filtration & Separation

Gateshead, England  
+44 (0) 191 402 9000  
[www.parker.com/dhfn](http://www.parker.com/dhfn)

#### Parker Gas Separations

Etten-Leur, Netherlands  
+31 76 508 5300  
[www.parker.com/dhfn](http://www.parker.com/dhfn)

#### Hiross Airtek

Essen, Germany  
+49 2054 9340  
[www.parker.com/hzfd](http://www.parker.com/hzfd)

Padova, Italy  
+39 049 9712 111  
[www.parker.com/hzfd](http://www.parker.com/hzfd)

### Engine Filtration & Water Purification

#### Racor

Dewsbury, England  
+44 (0) 1924 487 000  
[www.parker.com/rfd](http://www.parker.com/rfd)

#### Racor Research & Development

Stuttgart, Germany  
+49 (0)711 7071 290-10

### Hydraulic Filtration

#### Hydraulic Filter

Arnhem, Holland  
+31 26 3760376  
[www.parker.com/hfde](http://www.parker.com/hfde)

Urzala, Finland  
+358 20 753 2500

#### Condition Monitoring Parker Kittiwake

West Sussex, England  
+44 (0) 1903 731 470  
[www.kittiwake.com](http://www.kittiwake.com)

### Process Filtration

#### domnick hunter Process Filtration Parker Twin Filter BV

Birtley, England  
+44 (0) 191 410 5121  
[www.parker.com/processfiltration](http://www.parker.com/processfiltration)

## Asia Pacific

### Australia

Castle Hill, Australia  
+61 2 9634 7777  
[www.parker.com/australia](http://www.parker.com/australia)

### China

Shanghai, China  
+86 21 5031 2525  
[www.parker.com/china](http://www.parker.com/china)

### India

Chennai, India  
+91 22 4391 0700  
[www.parker.com/india](http://www.parker.com/india)

### Parker Fowler

Bangalore, India  
+91 80 2783 6794  
[www.johnfowlerindia.com](http://www.johnfowlerindia.com)

### Japan

Tokyo, Japan  
+81 45 870 1522  
[www.parker.com/japan](http://www.parker.com/japan)

### Korea

Hwaseon-City  
+82 31 359 0852  
[www.parker.com/korea](http://www.parker.com/korea)

### Singapore

Jurong Town, Singapore  
+65 6887 6300  
[www.parker.com/singapore](http://www.parker.com/singapore)

### Thailand

Bangkok, Thailand  
+66 2186 7000  
[www.parker.com/thailand](http://www.parker.com/thailand)

## Latin America

### Parker Comercio Ltda.

Filtration Division  
Sao Paulo, Brazil  
+55 12 4009 3500  
[www.parker.com/br](http://www.parker.com/br)

### Pan American Division

Miami, FL  
305 470 8800  
[www.parker.com/panam](http://www.parker.com/panam)

## Africa

Aeroporto Kempton Park, South Africa  
+27 11 9610700  
[www.parker.com/africa](http://www.parker.com/africa)

